

SBC-ASC(E) USER MANUAL



SBC-ASC(e) User Manual

Part Number 1E-04-00-0106

© 2013 American Auto-Matrix™

This document is protected by copyright and is the property of American Auto-Matrix. It may not be used or copied in whole or in part for any purpose other than that for which it is supplied without authorization. This document does not constitute any warranty, expressed or implied.

Every effort has been made to ensure that all information was correct at the time of publication. American Auto-Matrix reserves the right to alter specifications, performance, capabilities and presentation of this product at any time.

American Auto-Matrix and Auto-Matrix are trademarks of American Auto-Matrix and are not to be used for publication without the written consent of American Auto-Matrix.

All other brand names or product names are trademarks or registered trademarks of their respective companies or organizations.

WORLD HEADQUARTERS

American Auto-Matrix
One Technology Lane
Export, Pennsylvania 15632-8903 USA
Tel (1) 724-733-2000
Fax (1) 724-327-6124
Email aam@aamatrix.com
www.aamatrix.com

SECTION 1: OVERVIEW

This section provides a complete overview of the SBC-ASC(e) controller product manufactured by American Auto-Matrix. Detailed functionality descriptions of each key feature of the SBC-ASC(e) (inputs, outputs, etc.) are provided within this section.

IN THIS SECTION:

Description	1-3
Inputs	1-7
UIs Configured as Digital Inputs.....	1-7
UIs Configured for Linear Sensors.....	1-7
UIs Configured for Thermistor Sensors.....	1-7
Outputs.....	1-8
Binary Outputs	1-8
Analog Output	1-8
STATbus.....	1-9
Specifications	1-10
Networking	1-10
Terminations.....	1-10
Input Supply	1-10
Operating Environment	1-10
Dimensions	1-10
Agency Approvals	1-10

1.1 DESCRIPTION

The Smart Building Controller Series (SBC) unitary control modules are fundamental control devices in the American Auto-Matrix (AAM) System Architecture.

The SBC-ASC(e) is a unitary controller designed for application selectable configuration through the use of flash technology. The SBC-ASC(e) provides selectable applications for Rooftop, Heatpump, and Fancoil operations and has built-in control functions that correlate with the control applications including PID control, valve control, outside air temperature based economizer control, as well as many other functions that are reviewed in later sections of this manual.

Network communications occurs over American Auto-Matrix PUP Protocol. The SBC-ASC(e) is designed to operate in a stand-alone environment, or interact with other inter-networked devices. The device is configured using SoloPro, a commissioning environment and engineering tool used to configure SBC and SOLO family products that communicate PUP Protocol. This device can be programmed over the network, or in a direct-connect scenario.

The hardware layout of the SBC-ASC(e) consists of a main module with removable terminal blocks to connect universal inputs, analog outputs, digital outputs, an optically isolated digital input for status or pulse counting, and a dedicated input for connecting a single or networked set of SBC-STAT family devices using AAM's revolutionary sensor network known as STATbus. Other key components include diagnostic LEDs for network indication and digital output status, configurable jumpers for configuring universal inputs, and a real-time clock module for stand-alone or time-master applications.

The SBC-ASC(e) is available in two model variants:

Table 1-1: SBC-ASC(e) Models

Product Designation	BOs	AO	OI	UI	Real-time Clock
SBC-ASC	5 Relays	2	0	2	Optional - Field Installable and sold separately
SBC-ASC(e)	5 Relays	4	1	5	Integrated

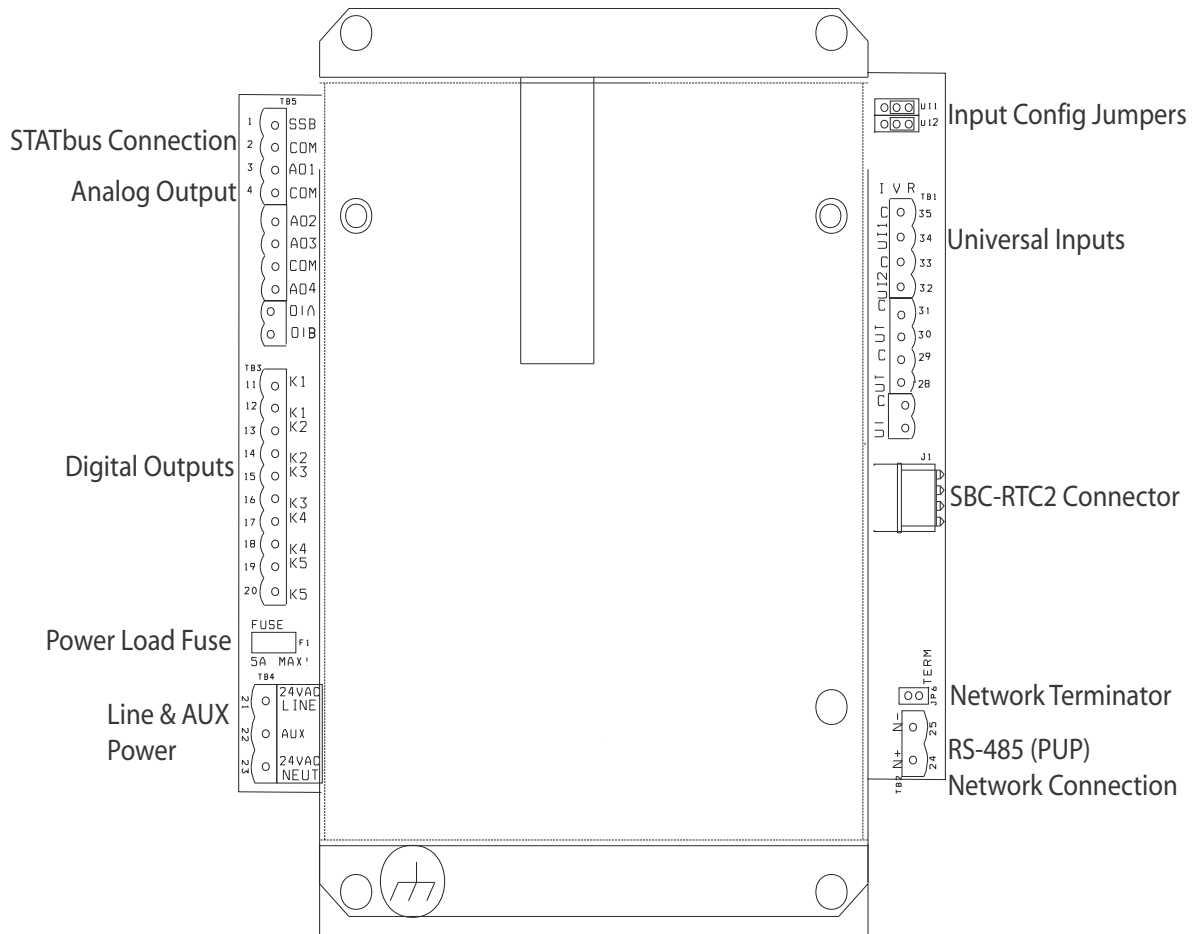

Figure 1-1 SBC-ASC Hardware Layout

Table 1-2: SBC-ASC Input/Output Board Assignments

Terminal	I/O	Description
1 (TB5)	SSB	STATbus Network Port Lead
2 (TB5)	COM	STATbus Network Port Common
3 (TB5)	AO1	Analog Output Channel 1
4 (TB5)	COM	AO Shared Common
5 (TB5)	AO2	Analog Output Channel 2
6 (TB5)	AO3	Analog Output Channel 3
7 (TB5)	COM	AO Shared Common
8 (TB5)	AO4	Analog Output Channel 4
9(TB5)	OIA	Optically Isolated (Digital Input) Side A
10 (TB5)	OIB	Optically Isolated (Digital Input) Side B
11 (TB3)	K1	Relay 1 Common
12 (TB3)	K1	Relay 1 Normally Open
13 (TB3)	K2	Relay 2 Common
14 (TB3)	K2	Relay 2 Normally Open
15 (TB3)	K3	Relay 3 Common
16 (TB3)	K3	Relay 3 Normally Open
17 (TB3)	K4	Relay 4 Common
18 (TB3)	K4	Relay 4 Normally Open
19 (TB3)	K5	Relay 5 Common
20 (TB3)	K5	Relay 5 Normally Open
21 (TB4)	24 VAC Line	24 Volt AC Control Power Input
22 (TB4)	AUX	24 Volt AC Auxiliary Output for DC Loads (5A Fuse)
23 (TB4)	24 VAC NEUT	24 Volt AC Neutral
24 (TB2)	N+	Positive 485 Network Communication Line
25 (TB2)	N-	Negative 485 Network Communication Line

Table 1-2: SBC-ASC Input/Output Board Assignments

Terminal	I/O	Description
26 (TB1)	UI5	Universal Input 5
27 (TB1)	COM	Common
28 (TB1)	UI4	Universal Input 4
29 (TB1)	COM	Common
30 (TB1)	UI3	Universal Input 3
31 (TB1)	COM	Input Common
32 (TB1)	UI2	Universal Input 2
33 (TB1)	COM	Input Common
34 (TB1)	UI1	Universal Input 1
35 (TB1)	COM	Input Common

1.2 INPUTS

Universal Inputs are high resolution (15-bit) UIs that can accept 0-20mA when in current mode, 0-1M Ω inputs when in resistance mode, or 0-10VDC when in voltage mode. A capacitor in the circuit provides a 10Hz low-pass filter. Over-range protection is provided to clamp normal over-range conditions and to protect against damage from electrostatic discharge (ESD). The UIs can be configured for alarming, setup/setback, filtering, and input polarity.

All of the UIs have associated selection jumpers for selecting current, resistance and voltage modes. The procedure for configuring these jumpers is explained in further detail in Section 2: Wiring and Installation.

1.2.1 UIs CONFIGURED AS DIGITAL INPUTS

Each Universal Input may be programmed to behave as a digital (on/off) input. UIs configured as digital can be defined for contact closures or any two-state inputs that are needed in a particular application. Typical digital input applications that are supported by the device are fan status, proof of flow, and occupancy detection (dependent on sensor type).

Digital configured UIs support two different types of contact alarming (changes from 0 to 1 or 1 to 0). Filtering options are also provided to program the amount of time required for input stability prior to alarming. The polarity of the digital input signal is also programmable within the input object.

1.2.2 UIs CONFIGURED FOR LINEAR SENSORS

Each Universal Input may be programmed as a linear scaled input for 0-10VDC input devices or 4-20mA input devices. Each of these types of devices may be programmed within minimum and maximum Engineering Units which define the end points of the analog values after they are read and converted to scaled Engineering Units.

For example, if you are using a linear, 4-20mA input device to measure carbon dioxide content (CO₂) in the air, you must configure the minimum and maximum scaled values for that input as 0 ppm (parts-per-million) and 5,000 ppm.

Linearly scaled analog inputs have associated high and low alarm limit properties that may be setup and setback during unoccupied periods (programmable times when zone control can be less stringent), the result is a wider operating range during unoccupied periods. In addition, a hysteresis can be applied to each alarm definition to control nuisance alarms that may occur between transitions.

High and low limit alarms may be disabled for a programmable length of time after the controller has been reset or after power has been cycled.

1.2.3 UIs CONFIGURED FOR THERMISTOR SENSORS

Each Universal Input may be programmed to accept a Precon, type-3, 10k ohm thermistor. A built-in table is provided for approximate linearization. Inputs using Precon, type 3 thermistors will use temperature ranges of -30.0° to 230.0° F (-35.0° to 110.0° C). The temperature units (Fahrenheit or Celsius) can be configured in the FF00;EM.

Thermistor inputs can have associated high and low alarm properties that may be setup and setback during unoccupied periods (programmable times when zone control can be less stringent), The result of a wider operating range during unoccupied periods. In addition, a hysteresis can be applied to each alarm definition to control nuisance alarms that may occur between transitions.

High and low limit alarms may be disabled for a programmable length of time after the controller has been reset or after power has been cycled.

1.3 OUTPUTS

The SBC-ASC(e) provides five (5) relays and up to four (4) Analog Outputs, dependent on model.

1.3.1 BINARY OUTPUTS

Binary Outputs provide On/Off control of output devices such as fans, valves, or cooling/heating stages. All BOs enforce minimum cycle time operation, determine the polarity, and provide a runtime alarm limit for the output. Relays have a 1A, 24VAC/DC rated load, normally open, non-polar contact. A tranzorb protection device is provided to suppress transients and contact arcing. Pulse width modulation (PWM) operation of floating valves or other devices is not recommended with relays.

CAUTION



Triacs are capable of switching a 1A, 24VDC load, but they will not turn off until the power load is removed.

NOTE



AAM recommends that output loads be wired so that one side of the load is grounded when possible.

1.3.2 ANALOG OUTPUT

The SBC-ASC(e) includes up to four (4) Analog Outputs, capable of outputting a 0-10VDC signal at an 8-bit resolution. The Analog Output may be programmed to operate in either manual mode or automatic mode in association with a PID Control Loop, Economizer Control, or other program block in the controller.

1.4 STATBUS

This product includes one STATbus (SSB) port for connecting a single or a network of up to 4 digital *SBC-STAT* room sensors. STATbus is a polarity insensitive, two wire sensor bus that can be used in either analog or digital mode. In analog mode, *SBC-ASC(e)* supports *SBC-STAT1* and *SBC-STAT2*.

In digital mode, *SBC-ASC(e)* supports digital *SBC-STAT1D*, *SBC-STAT2D*, and *SBC-STAT3*, as well as the ability to network up to four digital *SBC-STAT* sensors together on the same physical sensor bus. In networked *SBC-STAT* applications, the *SBC-ASC(e)* has the option to control based on a collective average, highest reading, lowest reading, or one specific *SBC-STAT*.

For single thermostat applications, the Rooftop and Heatpump profiles of the *NB-ASC(e)* can utilize the *SBC-RHT* for temperature and relative humidity monitoring. Only a single *SBC-RHT* sensor may be connected to a single *SBC-ASC(e)* deployed for Rooftop and Heatpump applications.

NOTE



Use of the *SBC-RHT* with this product is valid for single thermostat applications only. The *SBC-ASC(e)* does not support the ability to network multiple *SBC-RHT* sensors, or a mixture of digital *SBC-STAT* sensors and *SBC-RHT* sensors.

For information on *SBC-STAT* products, reference the *STAT User Manual* for complete details.

NOTE



Analog *SBC-STAT* sensors cannot be networked together on the same sensor bus. If your application requires multiple zone sensors, you must use digital *SBC-STAT* sensors.

Table 1-3: *SBC-STAT* Sensors Supported by *SBC-ASC(e)*

Analog <i>SBC-STAT</i>	Digital <i>SBC-STAT</i>
<i>SBC-STAT1</i>	<i>SBC-STAT1D</i>
<i>SBC-STAT2</i>	<i>SBC-STAT2D</i>
	<i>SBC-STAT3D</i>
	<i>SBC-RHT</i> (Rooftop and Heatpump only)

1.5 SPECIFICATIONS

1.5.1 NETWORKING

The following specifications are necessary for networking of the controller:

- . **line signaling:** EIA-485
- . **wiring:** shielded, twisted pair 18-22 AWG
- . **network protection:** dual tranzorbs, Hi ESD driver
- . **network configuration:** multidrop to 4,000ft. (1.5km) total
- . **protocol:** American Auto-Matrix PUP

1.5.2 TERMINATIONS

- . Pluggable terminal blocks for inputs, outputs, power, and network connection.

1.5.3 INPUT SUPPLY

- . NEC class 2 transformer (customer-supplied).
- . 22-26VAC, 50/60Hz, 10VA maximum, 5VA typical.
- . 5A fuse load protection.
- . PTC control electronics protection.

1.5.4 OPERATING ENVIRONMENT

- . **Temperature range:** 0–50°C.
- . **Humidity range:** 5–95% RH non-condensing.

1.5.5 DIMENSIONS

- . **Size:** 8.5 in. (21.6 cm) × 4.75 in. (14.6 cm) × 2.63 in. (6.7 cm) and 5.5 in (16.51 cm) × 4.75 in (14.6 cm) × 1.5 in. (3.81 cm)
- . **Shipping weight:** 2.04 lbs (.93 kg) and 1.86 lbs (.84 kg)

1.5.6 AGENCY APPROVALS

- . UL listed 916, Management Equipment, Energy (PAZX).
- . UL 873 Component-Temperature-Indicating and Regulating Equipment (XAPX2).
- . Complies with FCC rules Part 15, Class B Computing Device.
- . Complies with CE directives and standards.

SECTION 2: WIRING & INSTALLATION

This section reviews general wiring and installation practices. Detailed information is given to many areas including wiring for power, communications, inputs/outputs, and important safety requirements.

IN THIS SECTION:

Installation	2-3
Mounting the Controller	2-4
Wiring Requirements.....	2-5
Connecting Power	2-5
Universal Input Wiring	2-6
Connecting Voltage Inputs to UIs	2-6
Connecting 4-20mA Inputs to UIs	2-6
Connecting Status Inputs to UIs	2-7
Relay Output Wiring	2-7
Analog Output Wiring	2-7
SBC-STAT Wiring.....	2-9

2.1 INSTALLATION

The installation of the controller involves mounting the controller, supplying power, connecting to the communications network, and connecting input and output devices. All wiring connections to the device are made with the use of plug (female) & socket (male) terminal blocks (TB). The plug consists of terminal ports and adjustment screws. Input/output device, network, and power wires enter the terminal ports and are secured to the assembly with the adjustment screws. The socket consists of a row of pins and is permanently mounted to the printed circuit board (PCB).

When connecting/disconnecting the two parts of the TB, align the holes on the plug with the pins on the socket and avoid twisting, thus damaging the assembly. Such damage will void the product warranty.

WARNING



The sockets to which the terminal block plugs connect are permanently attached to the PCB. Twisting or applying torque when connecting/disconnecting will result in damage that will void the product warranty.

2.2 MOUNTING THE CONTROLLER

To mount the controller, perform the following steps:

CAUTION	
	The area in which the controller is being mounted should be free from moisture, to prevent against short-circuiting of on-board components.

1. If you are not using self-drilling mounting screws, use the controller backing as a template, mark the mounting holes on the mounting location. Remove the controller, then drill pilot holes in the mounting location. AAM recommends that at least two (2) screws be used to secure the *SBC-ASC(e)* controller to the mounting location.
2. Align the mounting holes of the *SBC-ASC(e)* controller with the pilot holes drilled in Step 1 and secure the controller to the mounting location using sheet metal screws. Sheet metal screws used to secure the controller to the mounting location are not supplied with the *SBC-ASC(e)* controllers.

2.3 WIRING REQUIREMENTS

WARNING



For your safety, power should be removed when performing any type of wiring to the controller.

Follow the recommended wiring guidelines to reduce the chance of operation and communication errors. If you do not use proper wiring techniques, your site may not meet Federal Communications Commission (FCC) Class A regulations for radio frequency interference (RFI) emissions. All EIA-485 communications networks should employ shielded, twisted pair wiring. Each twisted pair must be individually shielded. Unshielded cables must be placed in solid metal conduit alone. Communications wiring (as well as *SBC-STAT* and other input wiring) **should not** be routed together with—or close to—other wiring carrying DC switching, AC lines, fluorescent lighting or any other RFI/electromagnetic interference (EMI)-emitting source. Failure to use these types of conductors may result in various system communications problems such as excessive network retries, noise susceptibility, and loss of communication.

2.3.1 CONNECTING POWER

You must use a 24VAC 50/60Hz NEC class II transformer rated at 10VA maximum (5VA typical) for power supply to the controller. AAM recommends that at least 18AWG wiring be used, but the terminals can accommodate 14–22AWG. Connect power to the 24VAC LINE (TB4: Terminal 21) and 24VAC NEUT (TB4: Terminal 23) of the controller.

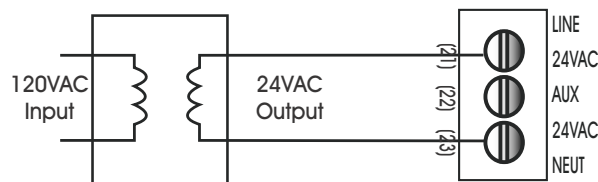

Figure 2-1 Connecting Power

CAUTION



AAM does not recommend sharing power transformers between devices. If this technique is used, AC polarity must be maintained throughout the power network. Product damage due to misapplication of power will void any warranty in place.

2.3.2 UNIVERSAL INPUT WIRING

The following section discusses common wiring applications for use with the controller. Deviations from the following examples should be discussed with AAM Technical Services prior to making modifications to a controller. Any modification other than those supported by AAM may void product warranty.

2.3.2.1 CONNECTING VOLTAGE INPUTS TO UIs

To connect a voltage input (0 - 10VDC analog input device) to a UI, perform the following:

1. Remove the IVR jumper for the corresponding Universal Input.
2. Wire voltage input device to UI and COM terminals accordingly.

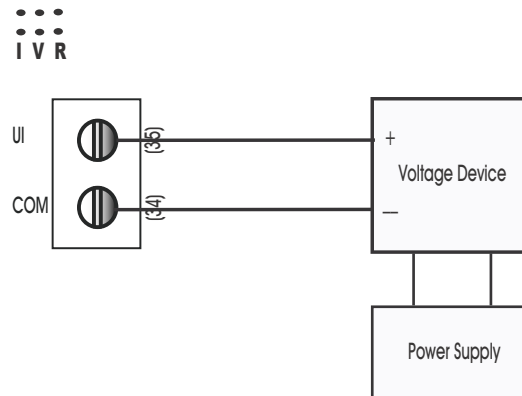

Figure 2-2 Wiring a Voltage Input to a Universal Input

2.3.2.2 CONNECTING 4-20mA INPUTS TO UIs

To connect a 4-20mA input to a UI, perform the following:

1. Jumper the I and V pins for the corresponding Universal Input on the IVR jumper block.
2. Wire 4-20mA device to UI and COM terminals accordingly.

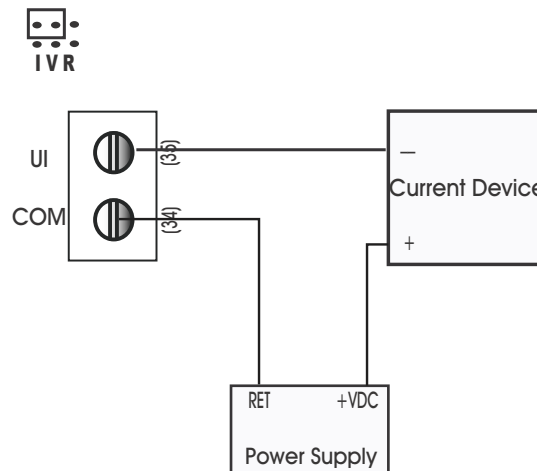

Figure 2-3 Wiring a 4-20mA Input to a Universal Input

2.3.2.3 CONNECTING STATUS INPUTS TO UIs

To connect a status input (digital input) to a UI, perform the following:

1. Jumper the V and R pins for the corresponding Universal Input on the IVR jumper block.
2. Wire digital input to UI and COM terminals accordingly.

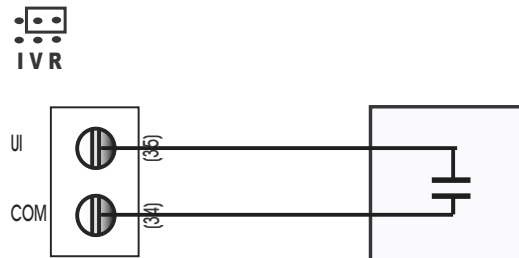

Figure 2-4 Wiring a Digital Input to a Universal Input

2.3.3 RELAY OUTPUT WIRING

This product uses relay outputs. Specifications of the outputs include:

- 24VAC/VDC, 1A rated load
- Isolated, normally open (Form 1A) contact
- Non-Polar

When wiring, connect one of the output load wires to either one of the relay output terminals, connect the remaining output load wire to a power source wire, then connect the other power source wire to the other remaining relay output terminal.

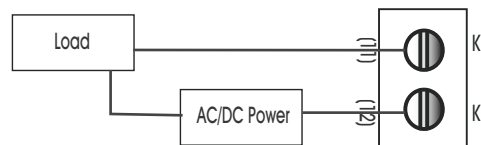

Figure 2-5 Wiring Relay Outputs

2.3.4 ANALOG OUTPUT WIRING

The analog output is a 0-10VDC output (8-bit resolution) which is typically used for PID Loop applications. Wiring the analog output to a device is straight-forward, by wiring the AO terminal to the positive side of the end device, followed by the COM terminal to the negative side of the end device.

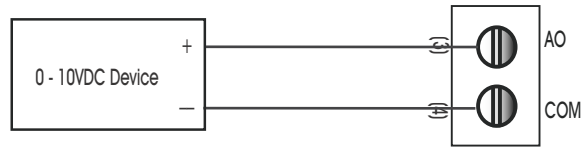

Figure 2-6 Analog Output Wired for a 0-10VDC Output

2.4 SBC-STAT WIRING

The SBC-ASC(e) supports the following SBC-STAT models:

- . SBC-STAT1
- . SBC-STAT1d
- . SBC-STAT2
- . SBC-STAT2d
- . SBC-STAT3
- . SBC-RHT (Rooftop and Heatpump applications only)

NOTE



The designation of 'd' in the SBC-STAT model indicates that the unit uses a digital sensor, and can support networking of multiple SBC-STAT devices.

SBC-STAT models with no 'd' designation cannot be networked and are intended for a one-to-one application between in and the controller.

NOTE



Use of the SBC-RHT with this product is valid for single thermostat applications only. The NB-ASC(e) does not support the ability to network multiple SBC-RHT sensors, or a mixture of digital SBC-STAT sensors and SBC-RHT sensors.

When connecting a single SBC-STAT or SBC-RHT to the controller, you should connect the SSB and COM terminals on the controller to the two outermost screw terminals in the STAT base, labeled B and Y.

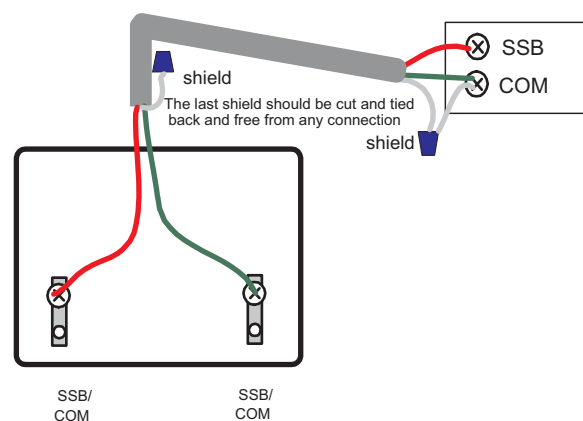

Figure 2-7 Wiring a single SBC-STAT or SBC-RHT

If your application involved connecting multiple digital thermostats to one controller, you simply daisy-chain each additional STAT to the first. Figure 2-8 shows two digital STATs connected to a controller with a wire

connected to the next device on the STATbus. The SBC-ASC(e) supports up to a maximum of four (4) networked SBC-STATs

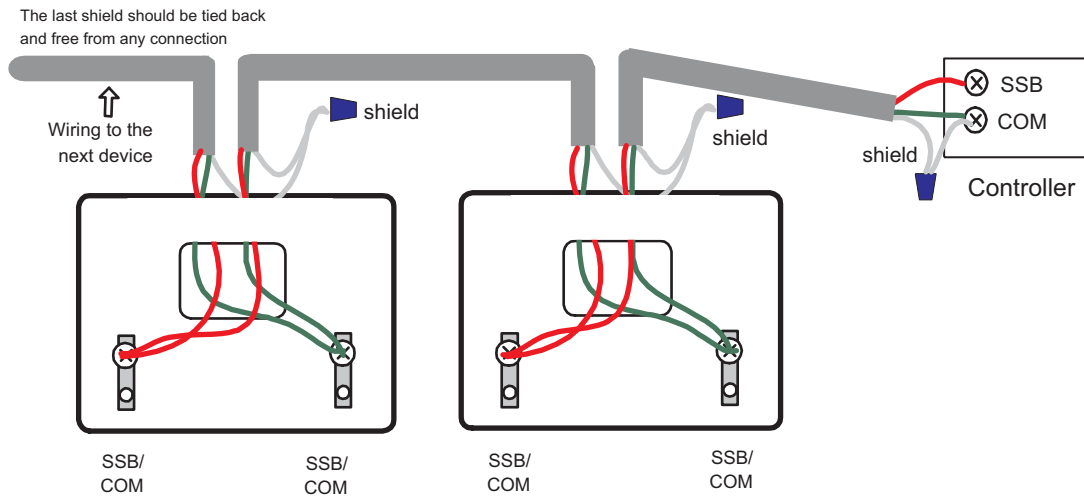

Figure 2-8 Networking Multiple SBC-STATs

NOTE



This product supports the ability to network SBC-STAT1D, SBC-STAT2d, and SBC-STAT3. SBC-RHT sensors cannot be used in networked applications.

SECTION 3: FUNDAMENTAL CONCEPTS

This section provides information on general concepts and theory that must be understood prior to setup and configuration of AAM Smart Building Control Series products.

IN THIS SECTION:

Fundamental Concepts	3-3
American Auto-Matrix PUP Protocol	3-3
Token Passing	3-3
Full Administrator	3-3
Irresponsible Peer	3-4
Non-Peer Devices	3-4
Token Error Recovery	3-4
PUP Data Structure	3-5
Channels	3-5
Attributes	3-5
Limitations and Implications	3-7
Communication Networking	3-7

3.1 FUNDAMENTAL CONCEPTS

This section of the user manual reviews standard fundamental concepts and provides an explanation of the prerequisite information necessary to know prior to installing American Auto-Matrix SBC-Series products.

3.1.1 AMERICAN AUTO-MATRIX PUP PROTOCOL

American Auto-Matrix PUP is a half-duplex EIA-485 network, designed to connect multiple SBC-series controllers together in a multi-drop (daisy chained) topology. All network communications occurs at 9.6kbps, unless modified by user intervention to a higher speed. A PUP network can contain up to a maximum of 64 devices connected at a given time.

In many cases, an installed network controller or area controller solution is a full administrator with configurable token passing down to devices. In this situation, all controllers connected to it are configured as irresponsible peers.

In network topologies that do not require a network controller or area controller solution, you may elect to configure a unitary controller as a full administrator. In this type of topology, a unitary controller can pass the token to other devices that may need to access the network for application purposes (peer-to-peer SPL applications, temperature broadcasts, etc.)

3.1.2 TOKEN PASSING

The SBC-ASC(e) is designed to maintain a master/slave relationship with other controllers on the same PUP network. The SBC-ASC(e) may also be configured to operate as a peer with other PUP devices such as SBC-GPC, SBC-ASC, and other such devices.

Peer-to-peer communication operates via token passing. Token passing is a communications scheme that allows PUP devices connected in a network to communicate with each other and share data among themselves. A “token” is passed from unit to unit on the network in a round-robin fashion. When any unit possesses the token, it performs any network activities for which it is responsible, and then passes the token to another unit. At any time, the unit that possesses the token is the only device permitted to initiate communications with another device on the network or to request information from it.

A device that receives the token may or may not need to perform network functions (e.g. read values from a remote device, broadcast information, etc.). If not, it will simply pass the token along the network. Determining how the token is passed along the network depends on which units may possess the token and what type of peer they are.

There are two types of devices that can potentially be connected on a PUP network:

- . Full Administrator
- . Irresponsible Peer

3.1.2.1 FULL ADMINISTRATOR

A full administrator is a device that passes network tokens to extend PUP communications. A full administrator maintains a list of peers (irresponsible peers or other full administrators) which get the token passed to them in a round robin fashion. Peers are addressed by referencing the Unit ID of the device that will receive the network token. A token is generally passed to a peer device with the understanding that the device that will receive the token will perform network transactions (read/write, broadcast, etc.). Once the peer device has finished using the token, it will be returned back to the source full administrator. A unit is typically configured as a full administrator by setting FF00;TP to a value of 1.

3.1.2.2 IRRESPONSIBLE PEER

An irresponsible peer is a device that can only return a network token to a full administrator which passed it the token. If an irresponsible peer is configured for an application that requires the network token, a full-administrator must pass the token to the irresponsible peer, through the use of its peer list.

3.1.2.3 NON-PEER DEVICES

While the SBC-ASC(e) cannot be configured as a non-peer, it is necessary to understand the existence of non-peer devices and how they react in a PUP environment. Some legacy SOLO devices (SOLO/TX version 1.xx, SOLO/HX v1.xx, SOLO/MX v1.xx, etc.) are non-peers. Non-peers are devices that were not intended to use a network token. Unlike a full administrator (which passes the token to other units that are specified in its peer list) or an irresponsible peer (which passes the token back to its sender), a non-peer has no knowledge of token passing and will drop the token if it receives one. Non-peers may exist on token passing networks - but should not be passed a network token. A configuration in such a manner will result in repeated token drops, thereby reducing the performance of your network communications and other control factors.

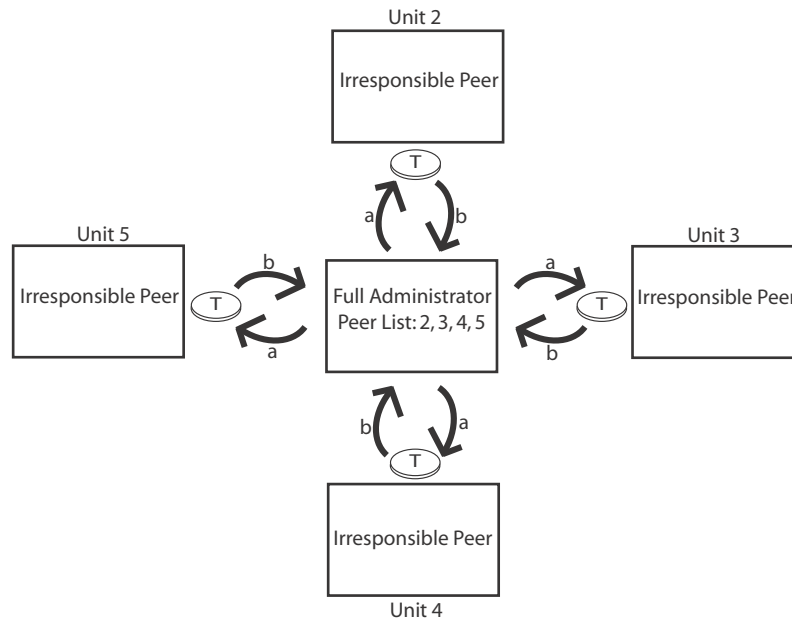

a = send token to peer
b = receive token back from peer

NOTE: The above illustration is a logical example, and not a physical network wiring example

Figure 3-1 Logic Example of PUP Network Token Passing

3.1.3 TOKEN ERROR RECOVERY

Because units can only perform network activities when they possess the token, it is important for the system to be able to recover the token if it is ever dropped or not passed. Full administrators are equipped with error recovery routines that allow them to “pick up” the token whenever it is dropped. Most devices capable of being configured as a full administrator have an FF00;ER parameter to enable token error recovery. Token error recovery is enabled when FF00;ER is set to a value of 1. If your device is configured as an irresponsible peer, FF00;ER should be disabled (ER=0).

3.2 PUP DATA STRUCTURE

The SBC-ASC(e) is an operator interface device for SBC-series products, as well as SOLO-series products and connects to networks using the American Auto-Matrix PUP protocol. The SBC-ASC(e) can control end-devices that are wired to it through programmable parameters located in memory.

3.2.1 CHANNELS

All PUP-based devices have memory locations that specify details of how a particular feature of a given system operates. These memory locations, known as Channels, can be accessed through engineering software such as SoloPro, by other peer controllers with SPL capabilities (Topics), an area controller solution, or the SBC-ASC(e).

Within a PUP device, there are two types of channels - Root Channels and Sub-Channels.

- Root channels are displayed with their full hexadecimal channel number (e.g. FE00), typically ending 00 as part of the hexadecimal location.
- Sub-Channels are indicated with the last two characters of the channel number. For example, sub-channel 1 would be addressed as FE01; subchannel 2 as FE02, etc. There can be up to 256 subchannels (00-FFh) for every PUP channel.

Root Channel FE00 - Universal Inputs
FE01 - Universal Input 1
FE02 - Universal Input 2
FE03 - Universal Input 3
FE04 - Universal Input 4
FE05 - Universal Input 5

Figure 3-2 Channel Example

3.2.2 ATTRIBUTES

Within each channel or subchannel are sets of parameters, dictating how features associated to a portion of the device may react. These parameters, known as Attributes, provide representational data to a user regarding how features are handled. Attributes are identified by a case sensitive two-character name; generally a mnemonic for the functionality that it represents. A good example of an attribute is a current value interpreted by a Universal Input. An attribute known as “**CV**” would represent the current value for the Universal Input channel.

Channel FE01
<pre>;ON - Object Name = OAT ;CV - Current Value = 72.0 ;RE - Reliability = 0 (Reliable) ;ST - Sensor Type = 7 (Precon Type 3)</pre>

Figure 3-3 Channel and Attribute Example

When discussing attribute functions and their operational relationships, attributes are displayed following the channel to which they belong. For example, the channel FF00 controller manufacturer attribute (**CM**) is shown as FF00;**CM**. All attributes appear in boldface to aid in locating descriptions of a particular attribute in the text of this document. Descriptions of the SBC-SD channels and their attributes are contained in the following sections of this manual.

3.3 LIMITATIONS AND IMPLICATIONS

In order to fully understand the capabilities and full range of possible applications, you should understand its limitations. Also, you should be aware of the implications of using certain features of this product.

3.3.1 COMMUNICATION NETWORKING

When installing the SBC-ASC(e) onto a PUP network, the device is similar to any other EIA-485 device connected to the network and should be networked as any other device - in a daisy chain format. Communication problems often are the result of poor wiring practices such as “star” networking or “t-tapping” a device to an existing network. While some instances of such wiring practices may provide satisfactory results in select environments, American Auto-Matrix recommends following good EIA-485 wiring practices at all times.’

SECTION 4: ROOFTOP CONFIGURATION

The following section provides configuration details regarding the SBC-ASC(e) Rooftop application. Please review the following sections carefully prior to configuring the controller.

IN THIS SECTION

Rooftop Sequence Overview	4-3
Selecting Your Application Mode	4-4
Configuring the Reversing Delay	4-4
Universal Input Configuration	4-5
Sensor Configuration	4-5
Universal Input Alarming	4-7
Supply & Outside Temperature Configuration	4-9
Supply/Discharge Temperature	4-9
Outside Air Temperature	4-9
Outside Air Temperature Broadcasts	4-9
Output Configuration	4-10
Fan Control	4-11
Fan Attributes	4-11
Fan Status	4-12
Cool 1 and 2	4-13
Lockout Configuration	4-13
Cool 1 Attributes	4-13
Cool 2 Attributes	4-14
Heat 1 and 2	4-15
Lockout Configuration	4-15
Heat 1 Attributes	4-15
Heat 2 Attributes	4-16
Economizer	4-17
PID Control	4-18
Scheduling	4-20
Weekly Scheduling	4-20
Holiday Calendar	4-20
Broadcast Schedule	4-20
Power-up State	4-20
Host Override	4-21
SBC-STAT Configuration	4-22
Setpoint Adjustment Configuration	4-22
User Override	4-22
Occupancy Detection	4-23
Pulse Counting	4-24

4.1 ROOFTOP SEQUENCE OVERVIEW

The Rooftop application of the SBC-ASC(e) provides standard rooftop control utilizing zone temperature control with integrated (optional) outside air temperature and supply temperature (discharge temp) mediation. The Rooftop application contains universal inputs and static output assignments for fan, heating stages and cooling stages to provide simple configuration.

- . Five (5) Universal Inputs - configurable for:
 - . Outside Air Temp & Discharge Air Temp Sensors
 - . Occupancy Detection Sensor
 - . Proof of Flow Sensing
 - . General Purpose Input Sensing
- . One (1) dedicated fan output
 - . Assignable by Universal Input or Opto-Isolated Digital Input selection
 - . Schedule control options to allow auto control (off in deadband) or run continuously
 - . Failure interlocking based on a specific input
- . Two (2) dedicated cooling (Outputs 2 and 3) and heating (Outputs 4 and 5) stages; includes the following features:
 - . Temperature offset control of stages - based on zone temperature
 - . Minimum runtime and off-time control
 - . Optional Discharge Temperature and Outside Air Temperature lockout of stages
 - . Stage deadband for stage disengaging -based on zone temperature
- . Outside Air Temperature-based economizer control
 - . Based on the input selected for Outside Air Temperature
 - . Can utilize one of the four available PID Control Loops
 - . Can utilize an unused 2nd stage of heating or cooling
 - . Provides minimum position control, staging delay, lockouts, and reset setpoint and limiting
- . Up to Four (4) dedicated PID Control sequences for proportional control
 - . Each PID Control Loop is internally connected to a respective Analog Output (PID1 -> AO1, etc.)
 - . PID Control Loops have several input variables including all inputs, and user adjust setpoints
 - . PID Control Loops have several reset variables including all inputs, and user adjust setpoints
 - . Interlock failure positioning

The SBC-ASC(e) also provides the following features:

- . Configurable Heating and Cooling Setpoints
 - . Includes defined setbacks for unoccupied and night setback schedule modes
- . Input Alarming
 - . Analog or Digital Alarming on all inputs (except opto-isolated digital input)
- . Weekly Schedule with four modes (Warmup, Occupied, Unoccupied, Night Setback)
 - . Can be used for days of week or multiple days of week
 - . Up to 10 specific dates can be defined for holiday modes (intended for stand-alone operation)
 - . All day override options for 24-hour control of specific days of the week
 - . Host Override of Schedule control - allowing global controllers to force the unit into a mode
- . Occupancy Detection
 - . Assignable by Universal Input selection
 - . Definable delays and duration timing for occupancy controlled units.
- . Pulse Counting
 - . Utilizes the opto-isolated digital input
 - . Can be configured to count rising edges, falling edges, or both
 - . Configurable factor and scale values.

4.2 SELECTING YOUR APPLICATION MODE

Prior to configuring equipment such as heating and cooling stages, you should first define the application mode that the Rooftop will conform to. There are three different application modes that the Rooftop can perform. They are as followed:

- . Cooling Only - utilizes cooling stages and optional economizer control. Optionally uses PID Control for other miscellaneous control applications carried out.
- . Heating Only - utilizes heating stages and optional economizer control. Optionally uses PID Control for other miscellaneous control applications carried out.
- . Supply Dependent (VST) - performs both heating and cooling with optional economizer control. Option-ally uses PID Control for other miscellaneous control applications carried out.

To configure your application mode, perform the following steps:

1. Using SoloPro, access *Temperature>Thermostat*
2. Locate **(BT) Control Mode**
3. For Cooling Only, set **(BT) Control Mode = 1** (Cooling Only)
4. For Heating Only, set **(BT) Control Mode = 2** (Heating Only)
5. For Heating & Cooling, set **(BT) Control Mode = 3** (Supply Dependent)

4.2.1 CONFIGURING THE REVERSING DELAY

In the Rooftop application, there is a configurable reversing delay that is imposed before a zone can call for heating after a period of cooling, or a call for cooling after a period of heating. By default, this parameter defaults to 15 minutes.

To modify this parameter, perform the following steps:

1. Using SoloPro, access *Temperature>Thermostat*
2. Locate **(RD) Reversing Delay**. Configure the value for a desired reversing delay.

4.3 UNIVERSAL INPUT CONFIGURATION

Universal Inputs permit the configuration of multiple sensor types, dependent on your application. The SBC-ASC(e) also supports alarm capabilities within its Universal Inputs. The following section provides a quick-start reference for initial configuration of inputs, as well as alarming. Complete information regarding each property available within Universal Inputs can be located in Section 5.

4.3.1 SENSOR CONFIGURATION

The following section discusses how to configure a Universal Input for a specific sensor type. Universal Input configuration includes modifying control logic programming inside the SBC-ASC(e) using SoloPro and IVR hardware jumper configuration. The IVR jumpers are located above the Universal Input terminal blocks on the top right-hand side of the unitary controller, as illustrated in Figure 4-1.

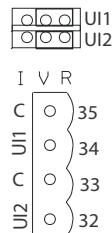

Figure 4-1 Universal Input IVR Jumper Location

4.3.1.1 DIGITAL INPUTS

To setup an input as a digital sensor, you must first configure the IVR jumper to VR, which places the input into a resistance setting.

In SoloPro, access *IO Setup>Universal Inputs> 1, 2, 3, 4, 5* (dependent on the UI), and set **(ST) Sensor Type** = 0 (Digital). Verify that **(OI) Override Input** = 0 (No) to assure that the value displayed in **(CV) Current Value** is the actual reading from the sensor. If **(RE) Channel Reliability** displays a value other than (0) Reliable, verify input wiring.

Table 4-1: Summary of Digital Input Configuration

Channel	Attribute	Value	Description
FE0x	(ST) Sensor Type	0	Digital sensor configuration
	(RE) Channel Reliability	0 (Reliable)	Input set to automatic mode

4.3.1.2 LINEAR SENSORS (0-10VDC)

To setup an input for a 0-10VDC sensor, completely remove the IVR jumper to configure the UI for voltage mode.

In SoloPro, access *IO Setup>Universal Inputs> 1, 2, 3, 4, 5* (dependent on the UI), and set **(ST) Sensor Type** = 2 (Linear). Configure **(MN) Minimum Scaled Value** and **(MX) Maximum Scaled Value** to the

minimum and maximum scaled values for **(CV) Current Value** is the actual reading from the sensor. Verify that **(OI) Override Input** = 0 (No) to assure that the value displayed in **(CV) Current Value** is the actual reading from the sensor. If **(RE) Channel Reliability** displays a value other than (0) Reliable, verify input wiring.

Table 4-2: Summary of an Example Linear Input Configuration

Channel	Attribute	Value	Description
UI0x	(ST) Sensor Type	2 (Linear)	Linear sensor configuration
	(MN) Minimum Scaled Value	0	Lowest present-value scale reading for the target sensor
	(MX) Maximum Scaled Value	100	Highest present-value scale reading for the target sensor
	(OI) Override Input	0 (No)	Input set to automatic mode

4.3.1.3 4-20mA SENSORS

To setup an input as a 4-20mA sensor, you must first configure the IVR jumper to IV, which places the input into a voltage setting.

In SoloPro, access *IO Setup>Universal Inputs> 1, 2, 3, 4, 5* (dependent on the UI), and set **(ST) Sensor Type** = 3 (4-20mA). Configure **(MN) Minimum Scaled Value** and **(MX) Maximum Scaled Value** to the minimum and maximum scaled values for **(CV) Current Value** is the actual reading from the sensor. Verify that **(OI) Override Input** = 0 (No) to assure that the value displayed in **(CV) Current Value** is the actual reading from the sensor. If **(RE) Channel Reliability** displays a value other than (0) Reliable, verify input wiring.

Table 4-3: Summary of an Example 4-20mA Input Configuration

Channel	Attribute	Value	Description
UI0x	(ST) Sensor Type	3	4-20mA sensor configuration
	(MN) Minimum Scaled Value	0	Lowest present-value scale reading for the target sensor
	(MX) Maximum Scaled Value	100	Highest present-value scale reading for the target sensor
	(OI) Override Input	0 (False)	Input set to automatic mode

4.3.1.4 THERMISTOR INPUT

To setup an input for thermistor readings, you must first configure the IVR jumper to VR, which places the input into a resistance setting.

In SoloPro, access *IO Setup>Universal Inputs> 1, 2, 3, 4, 5* (dependent on the UI), and set **(ST) Sensor Type** = 7 (Thermistor). Configure the minimum and maximum scaled values for **(CV) Current Value** is the

actual reading from the sensor. Verify that **(OI) Override Input** = 0 (No) to assure that the value displayed in **(CV) Current Value** is the actual reading from the sensor. If **(RE) Channel Reliability** displays a value other than (0) Reliable, verify input wiring.

Table 4-4: Summary of Thermistor Input Configuration

Channel	Attribute	Value	Description
UI0x	(ST) sensor type	7 (Thermistor)	Thermistor sensor configuration
	(OI) Override Input	0 (False)	Input set to automatic mode

4.3.1.5 ANALOG SBC-STAT1

To setup an input for temperature readings from an Analog SBC-STAT1, you must first configure the IVR jumper to VR, which places the input into a resistance setting.

In SoloPro, access *IO Setup>Universal Inputs> 1, 2, 3, 4, 5* (dependent on the UI), and set **(ST) Sensor Type** = 8 (Analog STAT1). Verify that **(OI) Override Input** = 0 (No) to assure that the value displayed in **(CV) Current Value** is the actual reading from the sensor. If **(RE) Channel Reliability** displays a value other than (0) Reliable, verify input wiring.

Table 4-5: Summary of Analog STAT1 Configuration

Channel	Attribute	Value	Description
UI0x	(ST) sensor type	8 (STAT1)	Analog STAT1 sensor configuration
	(OI) Override Input	0 (False)	Input set to automatic mode

4.3.2 UNIVERSAL INPUT ALARMING

The inputs supports general alarming conditions such as Off/On, On/Off, Change of State for digital sensors, and basic high/low limit alarming for analog sensors. To configure alarming, perform the following steps:

1. With your input configured set **(AE) Alarm Enable** to the specific alarming application desired.
2. For low limit alarms, configure **(LL) Low Alarm Limit** to the limit by which the value of your input must fall below before an alarm event is generated.
3. For high limit alarms, configure **(HL) High Alarm Limit** to the limit by which the value of your input must exceed before an alarm event is generated.

Table 4-6: Alarm Application Details

Value of AE	Alarm Condition
AE=0 (default)	disabled
AE=1	contact, 0→1

Table 4-6: Alarm Application Details

Value of AE	Alarm Condition
AE=2	contact, 1→0
AE=3	change of state, 1↔0
AE=4	low limit alarm
AE=5	high limit alarm

4.4 SUPPLY & OUTSIDE TEMPERATURE CONFIGURATION

The following section reviews configuration of the Supply and Outside Air Temperature sensors within the Rooftop application.

4.4.1 SUPPLY/DISCHARGE TEMPERATURE

The Rooftop application utilizes supply temperature for lockout application, as well as integrated supply control. Configuring this area is mandatory to make certain that stages of heating and cooling are or are not locked out. If your application does not require this temperature sensor, set **(OI) Override Supply Temperature** = 1 (Yes), located in *Temperature>Supply*.

If your application does involve integration of supply sensing, perform the following steps:

1. In SoloPro, access *Temperature>Supply*
2. Verify **(OI) Override Supply Temperature** = 0 (No)
3. Set **(IC) Supply Temperature Source** to the Universal Input your Supply Temperature sensor is connected to.
4. Set **(DD) Auto Mode Deadband** to a realistic value. The Auto Mode Deadband specifies the temperature difference by which the supply air must either exceed the heating setpoint to engage heating mode or fall below the cooling setpoint to engage cooling mode. A value of 0.0 will disable supply deadband control over heating and cooling modes. This attribute is commonly used when your application has been configured for Supply Depended mode.

4.4.2 OUTSIDE AIR TEMPERATURE

The Rooftop application utilizes outside air temperature for locking out heating and cooling stages, as well as for operating the Economizer routine. Configuring this area is mandatory to make certain that stages of heating and cooling are or are not locked out. If your application does not require this temperature sensor, set **(OI) Override Supply Temperature** = 1 (Yes) located in *Temperature>Outside*

If your application does involve integration of supply sensing, perform the following steps:

1. In SoloPro, access *Temperature>Outside*
2. Verify **(OI) Override Outside Temperature** = 0 (No)
3. Set **(IC) Outside Temperature Source** to the Universal Input your Outside Air Temperature sensor is connected to.

4.4.3 OUTSIDE AIR TEMPERATURE BROADCASTS

The Rooftop application can receive an Outside Air Temperature broadcast from another unit that is configured to perform broadcasting (such as an SBC-GPC). Additionally, the unit can also send a broadcast if desired. To receive or send Outside Air Temperature, perform the following steps:

1. In SoloPro, access *Network>OAT Broadcast*.
2. To receive a broadcast Outside Air Temperature, set **(RB) Receive Broadcast** = 1 (Yes).
3. To send Outside Air Temperature broadcasts, set **(BE) Broadcast Enable** = 1 (Yes).

4.5 OUTPUT CONFIGURATION

In order for outputs to be manipulated by any of the control strategies in the controller, all of the outputs (both Analog and Binary) must be configured for automatic control.

To configure Analog Outputs, perform the following steps:

1. Using SoloPro, access *I/O Setup>Analog Outputs (AO1 - AO4)*
2. For each Analog Output, set (AM) Control Mode = 1 (Automatic).
3. Minimum and Maximum Scaled Voltages and Engineering Units can be assigned here as well

When Analog Outputs are configured for manual mode, they cannot be manipulated by any of the internal control processes. However, the Analog Output can be manually written to.

To configure Binary Outputs, perform the following steps:

1. Using SoloPro, access *I/O Setup>Relay Outputs (K1 - K5)*
2. For each Binary Output, set (OI) Override = 2 (Auto).
3. Output polarity may also be configured in this section.

4.6 FAN CONTROL

The Rooftop application accommodates a fan which is connected to Binary Output 1 and is controlled by the settings in the FB01 channel. Setup involves configuring the following items:

- . Fan Attributes
- . Fan Status

4.6.1 FAN ATTRIBUTES

To configure the Fan Attributes, perform the following steps:

1. In SoloPro, access *Equipment> Fan (K1)*
2. Configure all properties accordingly.

Table 4-7: Fan Attributes Details

Attribute	Value and Interpretation
(FR) Minimum Run Time	Minimum amount of time, in minutes, the fan will stay on - prevents short-cycling
(FS) Minimum Off Time	Minimum amount of time, in minutes, the fan will stay off - prevents short-cycling.
(FX) Staging Delay	Defaults to 0.1. Can be assigned to any value greater than 0.1. A value of 0.0 will disable the fan, and is not recommended.
(FD) Shutoff Delay	The amount of time in seconds that the fan will remain on after all stages of cooling have been de-energized.
(FO) Occupied Mode	0 (Auto) - Fan turns off and off only when needed as defined by heating and cooling setpoints 1 (On) - Fan is always on.
(FU) Unoccupied Mode	0 (Auto) - Fan turns off and off only when needed as defined by heating and cooling setpoints 1 (On) - Fan is always on.
(FN) Night Setback Mode	0 (Auto) - Fan turns off and off only when needed as defined by heating and cooling setpoints 1 (On) - Fan is always on.
(DB) Fan Auto Mode Deadband	This attribute is used exclusively in conjunction with fan modes (FO, FU, FN) that are configured for Auto modes. When the device is in a schedule state where the fan operates in auto mode, the current zone temperature must exceed setpoint plus or minus the deadband temperature value in order for the fan to activate, followed by stages of heating or cooling. This attribute is useful for preventing the fan from turning on in situations where the zone temperature could possibly drift closely near mode changes.

Table 4-7: Fan Attributes Details

Attribute	Value and Interpretation
(MT) Min Run/Off Countdown Timer	<p>Reflects the amount of time remaining (in seconds) if the fan output is currently respecting minimum-on or minimum-off time.</p> <p>Examples:</p> <p>If (FR) = 1.0 and the Fan Turns on, (MT) will provide a countdown equal to the amount of time remaining for the minimum period being respected. In this case, a countdown from 60 seconds would be reflected by this property.</p> <p>If (FS) = 2.0 and the fan turns off, (MT) will provide a countdown equal to the amount of time remaining for the minimum period being respected. In this case, a countdown from 120 seconds would be reflected by this property.</p>

4.6.2 FAN STATUS

Fan Status is used to track the actual status of the fan output through use of a proof of flow sensor connected to a universal input or even the opto-isolated digital input. If you use a proof of flow sensor and the flow status does not match the output status, stages of heating and cooling will be locked out.

To configure Fan Status, perform the following steps:

1. Using SoloPro, access *Aux>Fan Status*
2. Select the input where your proof of flow sensor it attached using **(IC) Status Input**.
3. Enter a delay value **(PD) Delay**. This will impose a delay before considering a positive flow indication.

4.7 COOL 1 AND 2

The two cooling stages, controlled by BO2 (FB02) and BO3 (FB03), are cycled on and off to maintain the zone within a programmable deadband around a programmable setpoint. Setup involves configuring the following items:

- . Lockout Configuration
- . Cool 1 Attributes
- . Cool 2 Attributes

4.7.1 LOCKOUT CONFIGURATION

You can configure the cooling stages to be locked out based on a temperature lockout setpoint for both outside air temperature and/or discharge air temperature. If you do not plan to have lockouts, you must still configure the attributes accordingly. To configure, perform the following steps:

1. In SoloPro, access *Equipment>Cool 1 (K2)*
2. **(TL) DAT Low Temp Lockout** defines the lowest sensed temperature allowed before cooling is interrupted or not permitted to stage on. Enter your desired lockout value. If you do not plan to use a lockout based on Discharge Temperature, set **(TL) DAT Low Temp Lockout** = 999.0
3. **(CL) OAT Cooling Lockout** defines the lowest sensed temperature allowed before cooling is interrupted or not permitted to stage on. Enter your desired lockout value. If you do not plan to use a lockout based on Outside Air Temperature, set **(CL) OAT Cooling Lockout** = 999.0

4.7.2 COOL 1 ATTRIBUTES

To configure Cool 1 attributes, perform the following steps:

1. In SoloPro, access *Equipment>Cool 1 (K2)*
2. Configure your attributes accordingly.

Table 4-8: Cool 1 Attribute Details

Attribute	Value and Interpretation
(TO) Temp Offset	Indicates the temperature offset from your cooling setpoint before Cool 1 is engaged. Note that the stage may engage if the Staging Delay expires prior to the temperature offset.
(MX) Staging Delay	Indicates the amount of time, in minutes, before Cool 2 is engaged. Note that the stage may engage if the Temp Offset is exceeded prior to the Staging Delay.
(MR) Minimum Run Time	Minimum amount of time, in minutes, the stage will stay on - prevents short-cycling
(MS) Minimum Off Time	Minimum amount of time, in minutes, the stage will stay off - prevents short-cycling.
(DB) Deadband	The stage will not dis-engage until the Zone Temperature passes setpoint by the number of degrees specified here.

Table 4-8: Cool 1 Attribute Details

Attribute	Value and Interpretation
(MT) Min Run/Off Countdown Timer	<p>Reflects the amount of time remaining (in seconds) if the output is currently respecting minimum-on or minimum-off time.</p> <p>Examples:</p> <p>If (FR) = 1.0 and the output turns on, (MT) will provide a countdown equal to the amount of time remaining for the minimum period being respected. In this case, a countdown from 60 seconds would be reflected by this property.</p> <p>If (FS) = 2.0 and the output turns off, (MT) will provide a countdown equal to the amount of time remaining for the minimum period being respected. In this case, a countdown from 120 seconds would be reflected by this property.</p>

4.7.3 COOL 2 ATTRIBUTES

o configure Cool 1 attributes, perform the following steps:

1. In SoloPro, access *Equipment>Cool 2 (K3)*
2. Configure your attributes accordingly.

Table 4-9: Cool 2 Attribute Details

Attribute	Value and Interpretation
(TO) Temp Offset	Indicates the temperature offset from your cooling setpoint before Cool 2 is engaged. Note that the stage may engage if the Staging Delay expires prior to the temperature offset.
(MR) Minimum Run Time	Minimum amount of time, in minutes, the stage will stay on - prevents short-cycling
(MS) Minimum Off Time	Minimum amount of time, in minutes, the stage will stay off - prevents short-cycling.
(DB) Deadband	The stage will not dis-engage until the Zone Temperature passes setpoint by the number of degrees specified here.

4.8 HEAT 1 AND 2

The two heating stages, controlled by BO4 (FB04) and BO5 (FB05), are cycled on and off to maintain the zone within a programmable deadband around a programmable setpoint. Setup involves configuring the following items:

- . Lockout Configuration
- . Heat 1 Attributes
- . Heat 2 Attributes

4.8.1 LOCKOUT CONFIGURATION

You can configure the heating stages to be locked out based on a temperature lockout setpoint for both outside air temperature and/or discharge air temperature. If you do not plan to have lockouts, you must still configure the attributes accordingly. To configure, perform the following steps:

1. In SoloPro, access *Equipment>Heat 1 (K4)*
2. **(TH) DAT High Temp Lockout** defines the highest sensed temperature allowed before heating is interrupted or not permitted to stage on. Enter your desired lockout value. If you do not plan to use a lockout based on Discharge Temperature, set **(TH) DAT Low Temp Lockout** = 999.0
3. **(HL) OAT Heating Lockout** defines the highest sensed temperature allowed before heating is interrupted or not permitted to stage on. Enter your desired lockout value. If you do not plan to use a lockout based on Outside Air Temperature, set **(CH) OAT Cooling Lockout** = 999.0

4.8.2 HEAT 1 ATTRIBUTES

To configure Heat 1 attributes, perform the following steps:

1. In SoloPro, access *Equipment>Heat 1 (K4)*
2. Configure your attributes accordingly.

Table 4-10: Heat 1 Attribute Details

Attribute	Value and Interpretation
(TO) Temp Offset	Indicates the temperature offset from your cooling setpoint before Heat 1 is engaged. Note that the stage may engage if the Staging Delay expires prior to the temperature offset.
(MX) Staging Delay	Indicates the amount of time, in minutes, before Heat 2 is engaged. Note that the stage may engage if the Temp Offset is exceeded prior to the Staging Delay.
(MR) Minimum Run Time	Minimum amount of time, in minutes, the stage will stay on - prevents short-cycling
(MS) Minimum Off Time	Minimum amount of time, in minutes, the stage will stay off - prevents short-cycling.
(DB) Deadband	The stage will not dis-engage until the Zone Temperature passes setpoint by the number of degrees specified here.

Table 4-10: Heat 1 Attribute Details

Attribute	Value and Interpretation
(MT) Minimum Run/Off Timer	<p>Reflects the amount of time remaining (in seconds) if the output is currently respecting minimum-on or minimum-off time.</p> <p>Examples:</p> <p>If (FR) = 1.0 and the output turns on, (MT) will provide a countdown equal to the amount of time remaining for the minimum period being respected. In this case, a countdown from 60 seconds would be reflected by this property.</p> <p>If (FS) = 2.0 and the output turns off, (MT) will provide a countdown equal to the amount of time remaining for the minimum period being respected. In this case, a countdown from 120 seconds would be reflected by this property.</p>

4.8.3 HEAT 2 ATTRIBUTES

To configure Heat 2 attributes, perform the following steps:

1. In SoloPro, access *Equipment>Heat 2 (K5)*
2. Configure your attributes accordingly.

Table 4-11: Heat 1 Attribute Details

Attribute	Value and Interpretation
(TO) Temp Offset	Indicates the temperature offset from your cooling setpoint before Heat 1 is engaged. Note that the stage may engage if the Staging Delay expires prior to the temperature offset.
(MX) Staging Delay	Indicates the amount of time, in minutes, before Heat 2 is engaged. Note that the stage may engage if the Temp Offset is exceeded prior to the Staging Delay.
(MR) Minimum Run Time	Minimum amount of time, in minutes, the stage will stay on - prevents short-cycling
(MS) Minimum Off Time	Minimum amount of time, in minutes, the stage will stay off - prevents short-cycling.
(DB) Deadband	The stage will not dis-engage until the Zone Temperature passes setpoint by the number of degrees specified here.

4.9 ECONOMIZER

The Rooftop application includes an Economizer. Based on outside air temperature, the economizer can be configured to open a damper during calls for cooling to provide free cooling, allowing the space to cool down using cooler outside air as an alternative to running all stages of cooling. The economizer can utilize an available second stage of heating or cooling, or use one of the four PID control loops to control a proportional motor.

To use the economizer, your Outside Air Temperature sensor must be configured (see previous steps). To configure the economizer, perform the following steps:

1. Using SoloPro, access *Aux>Economizer*
2. Configure your attributes accordingly.

Table 4-12: Economizer Attribute Details

Attribute	Value and Interpretation
(EE) Economizer Enable	Specifies the PID Loop or Binary Output to be used for Economizer control. 0 = Disabled 1 = PID 1 2 = PID 2 3 = PID 3 4 = PID 4 5 = BO3 6 = BO5 Note - Using BO3 or BO5 will cancel out the second stage of heating or cooling respectively.
(OH) OAT High Limit	If the OAT rises above this setpoint, the economizer output will be set to the defined minimum position.
(OL) OAT Low Limit	If the OAT falls below this setpoint, the economizer output will be set to the defined minimum position.
(EM) Minimum Position	Specifies this minimum position for the economizer output when OAT rises or falls below the high and low limits
(ED) Economizer Staging Delay	Specifies how many minutes the controller will wait before using additional cooling stages after the economizer damper reaches 100%
(CM) Calculated Minimum Position	Displays the actual minimum position as calculated by the Economizer's internal control loop.
(MV) Reset Variable	Specifies an input for reset applications.
(MP) Reset Setpoint	Specifies the setpoint at which reset action occurs.
(MR) Maximum Reset	Specifies the maximum amount to reset the minimum position by when the variable reaches setpoint.
(ML) Reset Limit	Applied to determine the minimum position when (ML) is equal to the reset variable's input value.

4.10 PID CONTROL

The SBC-ASC(e) provides up to four (4) PID Control Loops for proportional control strategies. While some of these loops may be utilized by other strategies (such as Economizer or Valve Control - application dependent), the PID Control Loops can be used to control proportional equipment in an efficient manner.

Each PID Control is statically linked to a specific Analog Output. For example, PID Control 1 is linked to Analog Output 1, PID Control 2 is linked to Analog Output 2, etc.

The following section discusses the operation and configuration of PID Control in the SBC-ASC(e).

Table 4-13: PID Control Attributes

Attribute	Value and Interpretation
(SP) Loop Setpoint	Specifies the setpoint for loop control. The setpoint corresponds to the input variable specified in (IC) Input Channel
(CS) Control Setpoint	Indicates the current setpoint used as part of the control loop, displays the calculated setpoint with any setup/ setback, or setpoint adjustment from a connected SBC-STAT that may be applied.
(PO) Percent Output	Indicates the scaled output as configured in the actual Analog Output (FD0x).
(IN) Input Channel Value	Indicates the current value of the input variable specified in (IC) Input Channel .
(IC) Input Channel	Specifies the input reference that the loop will proportionally control by. Valid options include: 0 = Disable 1 = Zone Temperature 2 = Supply Temperature 4 = UI1 5 = UI2 6 = UI3 7 = UI4 8 = UI5 9 = Zone Heating (follows adjusted heating setpoint) 10 = Zone Cooling (follows adjusted cooling setpoint) 11 = Outside Air Temperature 13 = Relative Humidity
(MR) Maximum Reset	Specifies the maximum amount needed to reset to e loop setpoint based on when reset is being used.
(RC) Reset Variable Value	Indicates the current value of the reset variable specified in (RV) Reset Variable .

Table 4-13: PID Control Attributes

Attribute	Value and Interpretation
(RV) Reset Variable	Specifies the reset input reference that the loop will use to perform reset control. Valid options for reset include: 0 = Disable 1 = Zone Temperature 2 = Supply Temperature 4 = UI1 5 = UI2 6 = UI3 7 = UI4 8 = UI5 11 = Outside Air Temperature 13 = Relative Humidity
(RS) Reset Setpoint	Specifies the setpoint at which reset action begins. When the reset variable's value exceeds this setpoint, reset action will be used to determine the (CS) Control Setpoint .
(RL) Reset Limit	Specifies the value at which maximum reset is applied, based on the reset variable's value.
(DB) Deadband	Specifies the deadband for proportional control. The deadband straddles the setpoint. For example, a value of 2.0 would be applied to both the left and right side of the action.
(PB) Proportional Band	Specifies the variable range over which the output is changed based on input variable changes. The proportional band is centered around the setpoint for the loop.
(RP) Reset Period	Specifies the amount of time, in seconds, over which error history is accumulated for reset control.
(RT) Rate	Specifies the derivative rate for the loop
(CS) Control Sign	Specifies control action of the loop 0 = Normal/Direct, 1 = Reverse.
(SU) Setup/Setback	Specifies how much the setpoint should be lowered during unoccupied periods.
(ID) Interlock Enable/Disable	Enabled/Disables interlock failure modes for the control loop.
(P1) Interlock 1 Position	Fail position for the control loop when Interlock 1 occurs
(P2) Interlock 2 Position	Fail position for the control loop when Interlock 2 occurs
(P3) No Flow Position	Fail position if no flow or fan operation occurs.
(CE) Control Enable	Activation point for the control loop. To enable the loop, set to a value of 1(Yes).

4.11 SCHEDULING

Scheduling controls the current temperature setpoint of the SBC-ASC(e). There are multiple ways scheduling can be performed in the controller.

4.11.1 WEEKLY SCHEDULING

The SBC-ASC(e) contains six (6) Schedule channels, all of which are capable of performing 4-mode scheduling (Occupied, Unoccupied, Warmup, and Night Setback) for all days of the week including Holiday. Schedules can be cascaded to allow multiple occupancy periods for a specific day of week. Additionally, schedule channels can be configured for 24-hour operation using the **(AO) All Day Override** attribute.

To configure a Schedule channel, perform the following steps:

1. Using SoloPro, access *Schedules*>1, 2, 3, 4, 5, 6 (dependent on Schedule selection)
2. Set **(AD) Active Days** for each day that the schedule should follow
3. Set **(WO) Warmup Time**; **(OC) Occupied Time**; **(UN) Unoccupied Time**; and **(NS) Night Setback Time** for the times that the Schedule should enter into each occupancy state.
4. If you prefer that your schedule to operate in a single mode for an entire day, set **(AO) All-Day Override** to the desired schedule mode. The days selected on **(AD) Active Days** will operate to the setting of **(AO) All-Day Override**.

4.11.2 HOLIDAY CALENDAR

The SBC-ASC(e) contains ten (10) programmable attributes which can define days of the year that the controller should be consider as a holiday. These attributes are found in the F900 channel. They can be located in SoloPro at *Schedule*>*Clock/Calendar*. The attributes are **(H0)** through **(H9)**.

If the current date equals the value of one of the 10 programmable attributes, any schedule whose **(AD) Active Days** has its Holiday bit enabled, the Schedule will operate as defined.

4.11.3 BROADCAST SCHEDULE

The Broadcast Schedule is a schedule sent out over the network by another controller such as an SBC-GPC. The active internal schedule will be overridden if the SBC-ASC(e) is configured to receive network broadcast schedules. If the F005;**(RB) Receive Broadcast** property is enabled, the current schedule will reflect the F005;**(CV) Current Value** property. To configure the SBC-ASC(e) to receive network broadcast schedules:

1. Using SoloPro, access *Network*>*Schedule Broadcast*
2. Set **(RB) Receive Broadcast** = 1 (Yes)

4.11.4 POWER-UP STATE

If an unscheduled power loss occurs and power is restored, or if a soft reset of the controller is performed (FF00;**(RS) Reset Controller** = 1), the controller will operate in the schedule mode defined by the user in the **Power-up State** (FF00; **(PS) Power Up State**) attribute until a time synchronization received by the device from a time master. To set the schedule mode in which you want the device to operate upon power restoration or after a soft reset has occurred, select the value that corresponds to the desired power-up state. The possible states are listed in Table 4-14.

Table 4-14 : Power-up States

Value	Power-Up State
0	Unoccupied
1	Warm-up

Table 4-14 : Power-up States

Value	Power-Up State
2	Occupied
3	Night Setback

4.11.5 HOST OVERRIDE

In multi-device or zone situations, it may be advantageous to have a host or other peer device directly control the schedule state of the controller without broadcasts. In this case, the controller has a Host Override function in the Schedule Summary (F900) that can be utilized.

To configure the device to have its schedule controlled by an external source, set F900; **(HE) Host Override Local Schedules = 1** (Yes). Once set, the schedule of the device is then controlled through writes to the F900;**(HO) Host Schedule Setting** attribute.

The schedule mode set in **HO** will be the active mode unless:

- . a broadcast is received
- . an occupancy sensor is properly configured and occupancy is detected
- . user override occurs

4.12 SBC-STAT CONFIGURATION

The SBC-ASC(e) supports SBC-STAT model devices, as referenced in Section 2. There are a few configuration options available for a connected SBC-STAT, which this section reviews

4.12.1 SETPOINT ADJUSTMENT CONFIGURATION

Setpoint adjustment configuration can be achieved by accessing *Temperature>Setpoint Adjust* using SoloPro. Options found in this section include the following in the table below:

Table 4-15: Setpoint Adjustment Attributes

Attribute	Value and Interpretation
(ZS) Zone Midpoint	Specifies the comfort level for the zone.
(TS) User Setpoint Offset	Specifies an offset to apply to Zone Heating and Zone Cooling for PID Control.
(TM) User Adjust Increment	Specifies the magnitude of increment/decrement changes made to the setpoint.
(TT) User Adjust Duration	Specifies how much time, in minutes, a setpoint change is applied to the controller.
(SD) Calculated Setpoint Display	Specifies whether the offset, zone midpoint, heating setpoint, or cooling setpoint is displayed when a user performs setpoint adjustment.

4.12.2 USER OVERRIDE

If the active schedule controlling the SBC-ASC(e) is in unoccupied or night setback mode, user override is possible. If the user presses the up or down arrow push-button on the SBC-STAT2, SBC-STAT2D, or SBC-STAT3 and the FE00;(SE) **Override Enable/Disable** attribute is Enabled (value of 1), the unit will go into occupied mode.

The duration of this mode, which is also called extended occupancy, can be set by using the **(ED) Extended Occupancy Duration** property.

To configure the SBC-ASC(e) for user override ability via an SBC-STAT, perform the following steps:

1. Using SoloPro, access *Thermostat>Override*
2. Set **(SE) User Override** = 1 (Enabled)
3. Set **(ED) Extended Occupancy Duration** to however many minutes you wish for user override mode to occur.

When the unit's schedule is in unoccupied mode and the user enables override from a connect STAT, occupancy will occur for the amount of minutes specified in **(ED) Extended Occupancy Duration**. Once the time has elapsed, the unit will revert back to its configured schedule mode.

4.13 OCCUPANCY DETECTION

The occupancy detection feature enables the SBC-ASC(e) to automatically go to occupied mode, (also called extended occupancy) when a dedicated occupancy sensor indicates the monitored zone is occupied. The length of time that the controller will operate in extended occupancy is defined by the user in the FC01; **(MT) Extended Occupancy Duration** attribute. To configure the controller for occupancy detection capability, perform the following steps:

1. Using SoloPro, access *Aux>Occupancy Detector*
2. Set **(IC) Status Input** to the input that the occupancy detector is connected to.
3. Set **(MD) Extended Occupancy Delay** to the desired number of seconds the detector must indicate that occupancy is detected before overriding the zone. This prevents false triggering of the occupancy detection in the event someone or something quickly passes through the zone.
4. Set **(MT) Extended Occupancy Duration** to the desired number of minutes the controller is to remain in occupied mode once the zone has been occupied.

NOTE



If **(MT) Extended Occupancy Duration** is not set to a value greater than zero, the controller will not enter extended occupancy when it is detected that the zone is occupied.

NOTE



The input selected for the Occupancy Detection application must be configured as a digital input.

4.14 PULSE COUNTING

The SBC-ASC(e) provides an optically isolated digital input, which can be used for pulse counting. A Pulse application is provided, allowing users to perform count applications. To setup Pulse Counting, perform the following:

1. Using SoloPro, access *Aux>Pulse (OIA/OIB)*
2. Select a valid count mode from **(MD) Counter Mode**.
3. Enter your scale factor into **(SF) Pulse Scale Factor**

Your scaled value based on the number of pulses collected will appear in **(SV) Pulse Scale Value**.

SECTION 5: HEATPUMP CONFIGURATION

The following section provides configuration details regarding the SBC-ASC(e) Heatpump application. Please review the following sections carefully prior to configuring the controller.

IN THIS SECTION

Heatpump Sequence Overview	5-3
Selecting Your Application Mode	5-5
Configuring the Reversing Delay	5-5
Universal Input Configuration	5-6
Sensor Configuration	5-6
Universal Input Alarming	5-8
Supply & Outside Temperature Configuration	5-10
Supply/Discharge Temperature	5-10
Outside Air Temperature	5-10
Outside Air Temperature Broadcasts	5-10
Output Configuration	5-11
Fan Control	5-12
Fan Attributes	5-12
Fan Status	5-13
Reversing Valve and Defrost Cycle	5-14
Reversing Valve Attributes	5-14
Defrost Cycle Attributes	5-14
Stage 1 and 2	5-15
Cooling Lockout Configuration	5-15
Heating Lockout Configuration	5-15
Stage 1 Attributes	5-15
Stage 2 Attributes	5-16
Auxiliary Heat	5-18
Auxiliary Heat Attributes	5-18
Economizer	5-19
PID Control	5-20
Weekly Scheduling	5-22
Holiday Calendar	5-22
Broadcast Schedule	5-22
Power-up State	5-22
Host Override	5-23
SBC-STAT Configuration	5-24
Setpoint Adjustment Configuration	5-24
User Override	5-24
Occupancy Detection	5-25
Pulse Counting	5-26

5.1 HEATPUMP SEQUENCE OVERVIEW

The Heatpump application of the SBC-ASC(e) provides standard heat pump control utilizing zone temperature control with integrated (optional) outside air temperature and supply temperature (discharge temp) mediation. The Heatpump application contains universal inputs and static output assignments for fan, heating stages and cooling stages to provide simple configuration.

- . Five (5) Universal Inputs - configurable for:
 - . Outside Air Temp & Discharge Air Temp Sensors
 - . Occupancy Detection Sensor
 - . Proof of Flow Sensing
 - . General Purpose Input Sensing
- . Fan Output - Binary Output 1
 - . Assignable by Universal Input or Opto-Isolated Digital Input selection
 - . Schedule control options to allow auto control (off in deadband) or run continuously
 - . Failure interlocking based on a specific input
- . Reversing Valve and Defrost Cycle Configuration - Binary Output 2
 - . Configurable Settling Delay
 - . Optional Defrost Cycle Application.
- . Up to two (2) compressor stages of heating and cooling.
 - . Temperature offset control of stages - based on zone temperature
 - . Minimum runtime and off-time control
 - . Optional Discharge Temperature and Outside Air Temperature lockout of stages
 - . Stage deadband for stage dis-engagement, based on zone temperature
- . Auxiliary Heat Application
 - . Configurable for Single Stage or Dual Stage Auxiliary Heat
 - . Optional Stage Balancing with Outside Air and Supply Air lockouts
- . Up to Four (4) dedicated PID Control sequences for proportional control
 - . Each PID Control Loop is internally connected to a respective Analog Output (PID1 -> AO1, etc.)
 - . PID Control Loops have several input variables including all inputs, and user adjust setpoints
 - . PID Control Loops have several reset variables including all inputs, and user adjust setpoints
 - . Interlock failure positioning
- . Outside Air Temperature-based economizer control
 - . Based on the input selected for Outside Air Temperature
 - . Can utilize one of the four available PID Control Loops
 - . Can utilize an unused 2nd stage of heating or cooling
 - . Provides minimum position control, staging delay, lockouts, and reset setpoint and limiting

The SBC-ASC(e) also provides the following features:

- . Configurable Heating and Cooling Setpoints
 - . Includes defined setbacks for unoccupied and night setback schedule modes
- . Input Alarming
 - . Analog or Digital Alarming on all inputs (except opto-isolated digital input)
- . Weekly Schedule with four modes (Warmup, Occupied, Unoccupied, Night Setback)
 - . Can be used for days of week or multiple days of week
 - . Up to 10 specific dates can be defined for holiday modes (intended for stand-alone operation)
 - . All day override options for 24-hour control of specific days of the week
 - . Host Override of Schedule control - allowing global controllers to force the unit into a mode
- . Occupancy Detection
 - . Assignable by Universal Input selection
 - . Definable delays and duration timing for occupancy controlled units.
- . Pulse Counting
 - . Utilizes the opto-isolated digital input
 - . Can be configured to count rising edges, falling edges, or both

- . Configurable factor and scale values.

5.2 SELECTING YOUR APPLICATION MODE

Prior to configuring equipment such as heating and cooling stages, you should first define the application mode that the Heatpump will conform to. There are three different application modes that the Heatpump can perform. They are as followed:

- . Cooling Only - utilizes cooling only routines and optional economizer control. Optionally uses PID Control for other miscellaneous control applications carried out.
- . Heating Only - utilizes heating only routines and optional economizer control. Optionally uses PID Control for other miscellaneous control applications carried out.
- . Supply Dependent (VST) - performs both heating and cooling. Optionally uses PID Control for other miscellaneous control applications carried out.

To configure your application mode, perform the following steps:

1. Using SoloPro, access *Temperature>Thermostat*
2. Locate **(BT) Control Mode**
3. For Cooling Only, set **(BT) Control Mode = 1 (Cooling Only)**
4. For Heating Only, set **(BT) Control Mode = 2 (Heating Only)**
5. For Heating & Cooling, set **(BT) Control Mode = 3 (Supply Dependent)**

5.2.1 CONFIGURING THE REVERSING DELAY

In the Heatpump application, there is a configurable reversing delay that is imposed before a zone can call for heating after a period of cooling, or a call for cooling after a period of heating. By default, this parameter defaults to 15 minutes.

To modify this parameter, perform the following steps:

1. Using SoloPro, access *Temperature>Thermostat*
2. Locate **(RD) Reversing Delay**. Configure the value for a desired reversing delay.

5.3 UNIVERSAL INPUT CONFIGURATION

Universal Inputs permit the configuration of multiple sensor types, dependent on your application. The SBC-ASC(e) also supports alarm capabilities within its Universal Inputs. The following section provides a quick-start reference for initial configuration of inputs, as well as alarming. Complete information regarding each property available within Universal Inputs can be located in Section 5.

5.3.1 SENSOR CONFIGURATION

The following section discusses how to configure a Universal Input for a specific sensor type. Universal Input configuration includes modifying control logic programming inside the SBC-ASC(e) using SoloPro and IVR hardware jumper configuration. The IVR jumpers are located above the Universal Input terminal blocks on the top right-hand side of the unitary controller, as illustrated in Figure 5-1.

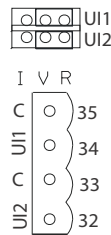

Figure 5-1 Universal Input IVR Jumper Location

5.3.1.1 DIGITAL INPUTS

To setup an input as a digital sensor, you must first configure the IVR jumper to VR, which places the input into a resistance setting.

In SoloPro, access *IO Setup>Universal Inputs> 1, 2, 3, 4, 5* (dependent on the UI), and set **(ST) Sensor Type** = 0 (Digital). Verify that **(OI) Override Input** = 0 (No) to assure that the value displayed in **(CV) Current Value** is the actual reading from the sensor. If **(RE) Channel Reliability** displays a value other than (0) Reliable, verify input wiring.

Table 5-1: Summary of Digital Input Configuration

Channel	Attribute	Value	Description
FE0x	(ST) Sensor Type	0	Digital sensor configuration
	(RE) Channel Reliability	0 (Reliable)	Input set to automatic mode

5.3.1.2 LINEAR SENSORS (0-10VDC)

To setup an input for a 0-10VDC sensor, completely remove the IVR jumper to configure the UI for voltage mode.

In SoloPro, access *IO Setup>Universal Inputs> 1, 2, 3, 4, 5* (dependent on the UI), and set **(ST) Sensor Type** = 2 (Linear). Configure **(MN) Minimum Scaled Value** and **(MX) Maximum Scaled Value** to the

minimum and maximum scaled values for **(CV) Current Value** is the actual reading from the sensor. Verify that **(OI) Override Input** = 0 (No) to assure that the value displayed in **(CV) Current Value** is the actual reading from the sensor. If **(RE) Channel Reliability** displays a value other than (0) Reliable, verify input wiring.

Table 5-2: Summary of an Example Linear Input Configuration

Channel	Attribute	Value	Description
UI0x	(ST) Sensor Type	2 (Linear)	Linear sensor configuration
	(MN) Minimum Scaled Value	0	Lowest present-value scale reading for the target sensor
	(MX) Maximum Scaled Value	100	Highest present-value scale reading for the target sensor
	(OI) Override Input	0 (No)	Input set to automatic mode

5.3.1.3 4-20mA SENSORS

To setup an input as a 4-20mA sensor, you must first configure the IVR jumper to IV, which places the input into a voltage setting.

In SoloPro, access *IO Setup>Universal Inputs> 1, 2, 3, 4, 5* (dependent on the UI), and set **(ST) Sensor Type** = 3 (4-20mA). Configure **(MN) Minimum Scaled Value** and **(MX) Maximum Scaled Value** to the minimum and maximum scaled values for **(CV) Current Value** is the actual reading from the sensor. Verify that **(OI) Override Input** = 0 (No) to assure that the value displayed in **(CV) Current Value** is the actual reading from the sensor. If **(RE) Channel Reliability** displays a value other than (0) Reliable, verify input wiring.

Table 5-3: Summary of an Example 4-20mA Input Configuration

Channel	Attribute	Value	Description
UI0x	(ST) Sensor Type	3	4-20mA sensor configuration
	(MN) Minimum Scaled Value	0	Lowest present-value scale reading for the target sensor
	(MX) Maximum Scaled Value	100	Highest present-value scale reading for the target sensor
	(OI) Override Input	0 (False)	Input set to automatic mode

5.3.1.4 THERMISTOR INPUT

To setup an input for thermistor readings, you must first configure the IVR jumper to VR, which places the input into a resistance setting.

In SoloPro, access *IO Setup>Universal Inputs> 1, 2, 3, 4, 5* (dependent on the UI), and set **(ST) Sensor Type** = 7 (Thermistor). Configure the minimum and maximum scaled values for **(CV) Current Value** is the

actual reading from the sensor. Verify that **(OI) Override Input** = 0 (No) to assure that the value displayed in **(CV) Current Value** is the actual reading from the sensor. If **(RE) Channel Reliability** displays a value other than (0) Reliable, verify input wiring.

Table 5-4: Summary of Thermistor Input Configuration

Channel	Attribute	Value	Description
UI0x	(ST) sensor type	7 (Thermistor)	Thermistor sensor configuration
	(OI) Override Input	0 (False)	Input set to automatic mode

5.3.1.5 ANALOG SBC-STAT1

To setup an input for temperature readings from an Analog SBC-STAT1, you must first configure the IVR jumper to VR, which places the input into a resistance setting.

In SoloPro, access *IO Setup>Universal Inputs> 1, 2, 3, 4, 5* (dependent on the UI), and set **(ST) Sensor Type** = 8 (Analog STAT1). Verify that **(OI) Override Input** = 0 (No) to assure that the value displayed in **(CV) Current Value** is the actual reading from the sensor. If **(RE) Channel Reliability** displays a value other than (0) Reliable, verify input wiring.

Table 5-5: Summary of Analog STAT1 Configuration

Channel	Attribute	Value	Description
UI0x	(ST) sensor type	8 (STAT1)	Analog STAT1 sensor configuration
	(OI) Override Input	0 (False)	Input set to automatic mode

5.3.2 UNIVERSAL INPUT ALARMING

The inputs supports general alarming conditions such as Off/On, On/Off, Change of State for digital sensors, and basic high/low limit alarming for analog sensors. To configure alarming, perform the following steps:

1. With your input configured set **(AE) Alarm Enable** to the specific alarming application desired.
2. For low limit alarms, configure **(LL) Low Alarm Limit** to the limit by which the value of your input must fall below before an alarm event is generated.
3. For high limit alarms, configure **(HL) High Alarm Limit** to the limit by which the value of your input must exceed before an alarm event is generated.

Table 5-6: Alarm Application Details

Value of AE	Alarm Condition
AE=0 (default)	disabled
AE=1	contact, 0→1

Table 5-6: Alarm Application Details

Value of AE	Alarm Condition
AE=2	contact, 1→0
AE=3	change of state, 1↔0
AE=4	low limit alarm
AE=5	high limit alarm

5.4 SUPPLY & OUTSIDE TEMPERATURE CONFIGURATION

The following section reviews configuration of the Supply and Outside Air Temperature sensors within the Heatpump application.

5.4.1 SUPPLY/DISCHARGE TEMPERATURE

The Heatpump application utilizes supply temperature for lockout application, as well as integrated supply control. Configuring this area is mandatory to make certain that stages of heating and cooling are or are not locked out. If your application does not require this temperature sensor, set **(OI) Override Supply Temperature** = 1 (Yes), located in *Temperature>Supply*.

If your application does involve integration of supply sensing, perform the following steps:

1. In SoloPro, access *Temperature>Supply*
2. Verify **(OI) Override Supply Temperature** = 0 (No)
3. Set **(IC) Supply Temperature Source** to the Universal Input your Supply Temperature sensor is connected to.
4. Set **(DD) Auto Mode Deadband** to a realistic value. The Auto Mode Deadband specifies the temperature difference by which the supply air must either exceed the heating setpoint to engage heating mode or fall below the cooling setpoint to engage cooling mode. A value of 0.0 will disable supply deadband control over heating and cooling modes. This attribute is commonly used when your application has been configured for Supply Depended mode.

5.4.2 OUTSIDE AIR TEMPERATURE

The Heatpump application utilizes outside air temperature for locking out heating and cooling stages, as well as for operating the Economizer routine. Configuring this area is mandatory to make certain that stages of heating and cooling are or are not locked out. If your application does not require this temperature sensor, set **(OI) Override Supply Temperature** = 1 (Yes) located in *Temperature>Outside*

If your application does involve integration of supply sensing, perform the following steps:

1. In SoloPro, access *Temperature>Outside*
2. Verify **(OI) Override Outside Temperature** = 0 (No)
3. Set **(IC) Outside Temperature Source** to the Universal Input your Outside Air Temperature sensor is connected to.

5.4.3 OUTSIDE AIR TEMPERATURE BROADCASTS

The Heatpump application can receive an Outside Air Temperature broadcast from another unit that is configured to perform broadcasting (such as an SBC-GPC). Additionally, the unit can also send a broadcast if desired. To receive or send Outside Air Temperature, perform the following steps:

1. In SoloPro, access *Network>OAT Broadcast*.
2. To receive a broadcast Outside Air Temperature, set **(RB) Receive Broadcast** = 1 (Yes).

To send Outside Air Temperature broadcasts, set **(BE) Broadcast Enable** = 1 (Yes).

5.5 OUTPUT CONFIGURATION

In order for outputs to be manipulated by any of the control strategies in the controller, all of the outputs (both Analog and Binary) must be configured for automatic control.

To configure Analog Outputs, perform the following steps:

1. Using SoloPro, access I/O Setup>Analog Outputs (AO1 - AO4)
2. For each Analog Output, set (AM) Control Mode = 1 (Automatic).
3. Minimum and Maximum Scaled Voltages and Engineering Units can be assigned here as well

When Analog Outputs are configured for manual mode, they cannot be manipulated by any of the internal control processes. However, the Analog Output can be manually written to.

To configure Binary Outputs, perform the following steps:

1. Using SoloPro, access I/O Setup>Relay Outputs (K1 - K5)
2. For each Binary Output, set (OI) Override = 2 (Auto).
3. Output polarity may also be configured in this section.

5.6 FAN CONTROL

The Heatpump application accommodates a fan which is connected to Binary Output 1 and is controlled by the settings in the FB01 channel. Setup involves configuring the following items:

- . Fan Attributes
- . Fan Status

5.6.1 FAN ATTRIBUTES

To configure the Fan Attributes, perform the following steps:

1. In SoloPro, access *Equipment > Fan (K1)*
2. Configure all properties accordingly.

Table 5-7: Fan Attributes Details

Attribute	Value and Interpretation
(FR) Minimum Run Time	Minimum amount of time, in minutes, the fan will stay on - prevents short-cycling
(FS) Minimum Off Time	Minimum amount of time, in minutes, the fan will stay off - prevents short-cycling.
(FX) Staging Delay	Defaults to 0.1. Can be assigned to any value greater than 0.1. A value of 0.0 will disable the fan, and is not recommended.
(FD) Shutoff Delay	The amount of time in seconds that the fan will remain on after all stages of cooling have been de-energized.
(FO) Occupied Mode	0 (Auto) - Fan turns off and off only when needed as defined by heating and cooling setpoints 1 (On) - Fan is always on.
(FU) Unoccupied Mode	0 (Auto) - Fan turns off and off only when needed as defined by heating and cooling setpoints 1 (On) - Fan is always on.
(FN) Night Setback Mode	0 (Auto) - Fan turns off and off only when needed as defined by heating and cooling setpoints 1 (On) - Fan is always on.
(DB) Fan Auto Mode Deadband	This property is used exclusively in conjunction with fan modes (FO, FU, FN) that are configured for Auto modes. When the device is in a schedule state where the fan operates in auto mode, the current zone temperature must exceed setpoint plus or minus the deadband temperature value in order for the fan to activate, followed by stages of heating or cooling. This property is useful for preventing the fan from turning on in situations where the zone temperature could possibly drift closely near mode changes.

Table 5-7: Fan Attributes Details

Attribute	Value and Interpretation
(MT) Min Run/Off Countdown Timer	<p>Reflects the amount of time remaining (in seconds) if the fan output is currently respecting minimum-on or minimum-off time.</p> <p>Examples:</p> <p>If (FR) = 1.0 and the Fan Turns on, (MT) will provide a countdown equal to the amount of time remaining for the minimum period being respected. In this case, a countdown from 60 seconds would be reflected by this property.</p> <p>If (FS) = 2.0 and the fan turns off, (MT) will provide a countdown equal to the amount of time remaining for the minimum period being respected. In this case, a countdown from 120 seconds would be reflected by this property.</p>

5.6.2 FAN STATUS

Fan Status is used to track the actual status of the fan output through use of a proof of flow sensor connected to a universal input or even the opto-isolated digital input. If you use a proof of flow sensor and the flow status does not match the output status, stages of heating and cooling will be locked out.

To configure Fan Status, perform the following steps:

1. Using SoloPro, access Aux>Fan Status
2. Select the input where your proof of flow sensor it attached using (IC) Status Input.
3. Enter a delay value **(PD) Delay**. This will impose a delay before considering a positive flow indication.

5.7 REVERSING VALVE AND DEFROST CYCLE

The Reversing Valve output (Binary Output 2) is used to switch between heating and cooling modes based on zone demand. When heating or cooling is required, the reversing valve will open/close and then allow for a single or dual stage of heating or cooling to energize.

The optional defrost cycle application provides a defrost mode for Heatpump. This application assumes that a valid temperature sensor (commonly installed along the coil) has been connected to an available universal input. The application also permits Outside Air Temperature to be used if necessary. When the measured variable drops below the **Enter Defrost Setpoint** parameter, the reversing valve will switch to cooling mode, and then enable heating stages to defrost the coils. The controller will remain in this mode for the amount of time based on the **Maximum Defrost Cycle Time** parameter. If the measured variable exceeds the **Exit Defrost Setpoint** parameter or if the maximum amount of time expires, the heating stages will disable and the reversing valve will return to heating mode. The next defrost cycle will then occur based on the **Programmed Time Between Defrost Cycles** parameter.

Setup involves configuring the following items:

- Reversing Valve Attributes
- Defrost Cycle Attributes

5.7.1 REVERSING VALVE ATTRIBUTES

Attribute configuration of the Reversing Valve is quite simple and involved two properties. They can be located in SoloPro by accessing *Equipment>Reversing Valve*

- **(SD) Settling Delay** - specifies how many seconds that is imposed both before and after the reversing valve state is changed. The delay begins once all stages have been shut down. Stages will not energize for this period after the valve state is changed.
- **polarity** - permits configuration of the output polarity. This property is set based on the valve status used for cooling states.

5.7.2 DEFROST CYCLE ATTRIBUTES

Attribute configuration for defrost cycle applications involves the following properties located under *Equipment>Reversing Valve*. Select attributes are used to provide feedback status relative to the operation of the defrost cycle application.

- **(FB) Defrost Status** - read-only feedback attribute indicating if defrost logic is active, and if a defrost cycle is in progress. By default, the device is not configured for defrost cycle applications.
- **(IN) Defrost Input Select** - specified which input to use as the measured variable for defrost cycles. This input will commonly be set to the corresponding universal input which has a coil temperature sensor connected. However, the application permits any universal input to be used.
- **(ES) Enter Defrost Setpoint** - specified the value that the measured variable must drop below in order for defrost control to occur.
- **(XS) Exit Defrost Setpoint** - specifies the value that the measured variable must rises above in order for defrost control to terminate.
- **(PT) Programmed Time Between Defrost Cycles** - specifies the initial time period, in minutes, from the end of one cycle to the start of the next. The actual time may be adjusted automatically based on the length of time that an initial defrost cycle may have taken to complete.
- **(MC) Maximum Defrost Cycle Time** - specifies the maximum amount of time, in minutes, that a defrost cycle will last.
- **(AT) Adjusted Time Between Defrost Cycles** - read-only feedback property indicating an adjustment made to the **Programmed Time Between Defrost Cycle Times** based on previous cycles. If the previous cycle does not raise the temperature up to the value defined in the **Exit Defrost Setpoint**

5.8 STAGE 1 AND 2

Stages 1 and 2 are used to provide compressor driven heating and cooling based on the directional status of the Reversing Valve. The two cooling stages, controlled by BO2 (FB02) and BO3 (FB03), are cycled on and off to maintain the zone within a programmable deadband around a programmable setpoint. Setup involves configuring the following items:

- . Cooling Lockout Configuration
- . Heating Lockout Configuration
- . Stage 1 Attributes
- . Stage 2 Attributes

5.8.1 COOLING LOCKOUT CONFIGURATION

You can configure the cooling stages to be locked out based on a temperature lockout setpoint for both outside air temperature and/or discharge air temperature. If you do not plan to have lockouts, you must still configure the attributes accordingly. To configure, perform the following steps:

1. In SoloPro, access *Equipment>Stage 1 (K3)*
2. **(TL) DAT Low Temp Lockout** defines the lowest sensed temperature allowed before cooling is interrupted or not permitted to stage on. Enter your desired lockout value. If you do not plan to use a lockout based on Discharge Temperature, set **(TL) DAT Low Temp Lockout** = 999.0
3. **(CL) OAT Cooling Lockout** defines the lowest sensed temperature allowed before cooling is interrupted or not permitted to stage on. Enter your desired lockout value. If you do not plan to use a lockout based on Outside Air Temperature, set **(CL) OAT Cooling Lockout** = 999.0

5.8.2 HEATING LOCKOUT CONFIGURATION

You can configure the heating stages to be locked out based on a temperature lockout setpoint for both outside air temperature and/or discharge air temperature. If you do not plan to have lockouts, you must still configure the attributes accordingly. To configure, perform the following steps:

1. In SoloPro, access *Equipment>Stage 1 (K3)*
2. **(TH) DAT High Temp Lockout** defines the highest sensed temperature allowed before heating is interrupted or not permitted to stage on. Enter your desired lockout value. If you do not plan to use a lockout based on Discharge Temperature, set **(TH) DAT Low Temp Lockout** = 999.0
3. **(HL) OAT Heating Lockout** defines the highest sensed temperature allowed before heating is interrupted or not permitted to stage on. Enter your desired lockout value. If you do not plan to use a lockout based on Outside Air Temperature, set **(CH) OAT Cooling Lockout** = 999.0

5.8.3 STAGE 1 ATTRIBUTES

To configure Cool 1 attributes, perform the following steps:

1. In SoloPro, access *Equipment>Stage 1 (K3)*
2. Configure your attributes accordingly.

Table 5-8: Stage 1 Attribute Details

Attribute	Value and Interpretation
(CO) Cooling: Temp Offset	Indicates the temperature offset from your cooling setpoint before cooling stage 1 is engaged. Note that the stage may engage if the Staging Delay expires prior to the temperature offset.
(CR) Cooling: Min Run Time	Minimum amount of time, in minutes, the stage will stay on - prevents short-cycling

Table 5-8: Stage 1 Attribute Details

Attribute	Value and Interpretation
(CS) Cooling: Min Off Time	Minimum amount of time, in minutes, the stage will stay off - prevents short-cycling.
(CX) Cooling: Staging Delay	Indicates the amount of time, in minutes, before cooling stage 1 is engaged. Note that the stage may engage if the Temp Offset is exceeded prior to the Staging Delay.
(CB) Cooling: Deadband	The stage will not dis-engage until the Zone Temperature falls below the cooling setpoint by the number of degrees specified here.
(HO) Heating: Temp Offset	Indicates the temperature offset from your cooling setpoint before heating stage 1 is engaged. Note that the stage may engage if the Staging Delay expires prior to the temperature offset.
(HR) Heating: Min Run Time	Minimum amount of time, in minutes, the stage will stay on - prevents short-cycling
(HS) Heating: Min Off Time	Minimum amount of time, in minutes, the stage will stay off - prevents short-cycling.
(HX) Heating: Staging Delay	Indicates the amount of time, in minutes, before heating stage 1 is engaged. Note that the stage may engage if the Temp Offset is exceeded prior to the Staging Delay.
(HB) Heating: Deadband	The stage will not dis-engage until the Zone Temperature rises above the heating setpoint by the number of degrees specified here.
(AL) Heating: Low OAT Aux Limit	Defines an outside air temperature setpoint below which the compressor is left off and only Auxiliary Heat is used to provide heat. This has no effect if no Aux Heat stages are defined.

5.8.4 STAGE 2 ATTRIBUTES

o configure Stage 2 attributes, perform the following steps:

1. In SoloPro, access *Equipment>Stage 2 (K4)*
2. Configure your attributes accordingly.

Table 5-9: Stage 2 Attribute Details

Attribute	Value and Interpretation
(CO) Cooling: Temp Offset	Indicates the temperature offset from your cooling setpoint before cooling stage 2 is engaged. Note that the stage may engage if the Staging Delay expires prior to the temperature offset.
(CR) Cooling: Min Run Time	Minimum amount of time, in minutes, the stage will stay on - prevents short-cycling

Table 5-9: Stage 2 Attribute Details

Attribute	Value and Interpretation
(CS) Cooling: Min Off Time	Minimum amount of time, in minutes, the stage will stay off - prevents short-cycling.
(CB) Cooling: Deadband	The stage will not dis-engage until the Zone Temperature falls below the cooling setpoint by the number of degrees specified here.
(HO) Heating: Temp Offset	Indicates the temperature offset from your cooling setpoint before heating stage 1 is engaged. Note that the stage may engage if the Staging Delay expires prior to the temperature offset.
(HR) Heating: Min Run Time	Minimum amount of time, in minutes, the stage will stay on - prevents short-cycling
(HS) Heating: Min Off Time	Minimum amount of time, in minutes, the stage will stay off - prevents short-cycling.
(HB) Heating: Deadband	The stage will not dis-engage until the Zone Temperature rises above the heating setpoint by the number of degrees specified here.

5.9 AUXILIARY HEAT

The Auxiliary Heat application is used by the Heatpump to provide auxiliary heat in the event that normal compressor based stages have been unable to satisfy the zone. Auxiliary Heat can be configured for a single-stage - utilizing BO5 (FB05); or dual-stage - utilizing BO4 (FB04) and BO5 (FB05) on single-compressor units that need both a stage of auxiliary heat and an additional stage of auxiliary heat for emergency situations. Configuration involves the following steps:

- . Auxiliary Heat Attributes

5.9.1 AUXILIARY HEAT ATTRIBUTES

To configure the Auxiliary Heat attributes, perform the following steps:

1. In SoloPro, access *Equipment>Aux Heat*
2. Configure attributes accordingly.

Table 5-10: Auxiliary Heat Attribute Details

Attribute	Value and Interpretation
(RO) Aux Heat Application	0 = None 1 = Single Stage (K5) 2 = Dual Stage (K4 and K5) Note - If Dual Stage has been selected, K4 will become unavailable as a second stage compressor
(FR) Fan Flow Required	Specifies whether flow is required for auxiliary heat stages to operate
(BA) Balancing Enabled	Enables runtime-based balancing of stages as they are enabled (dual-stage only)
(SS) Aux Heat Setpoint	Setpoint at which auxiliary heat is enabled
(EM) Emergency Aux Heat Setpoint	Setpoint at which second stage of auxiliary heat is enabled
(ID) Interstage Delay	Specifies the time delay, in minutes, between each stage.
(HL) OAT Lockout	If the outside air temperature rises above the value specified in HL, auxiliary heat will not energize.
(TH) Supply Temp Lockout	If the supply temperature rises above the temperature setpoint specified in TH, auxiliary heat will not energize.

5.10 ECONOMIZER

The Heatpump application includes an Economizer. Based on outside air temperature, the economizer can be configured to open a damper during calls for cooling to provide free cooling, allowing the space to cool down using cooler outside air as an alternative to running all stages of cooling. The economizer can utilize an available second stage of heating or cooling, or use one of the four PID control loops to control a proportional motor.

To use the economizer, your Outside Air Temperature sensor must be configured (see previous steps). To configure the economizer, perform the following steps:

1. Using SoloPro, access *Aux>Economizer*
2. Configure your attributes accordingly.

Table 5-11: Economizer Attribute Details

Attribute	Value and Interpretation
(EE) Economizer Enable	Specifies the PID Loop or Binary Output to be used for Economizer control. 0 = Disabled 1 = PID 1 (FA11) 2 = PID 2 (FA12) 3 = PID 3 (FA13) 4 = PID 4 (FA14) 5 = BO3 (FB03) 6 = BO5 (FB05) Note - Using BO3 or BO5 will cancel out the second stage of heating or cooling respectively.
(OH) OAT High Limit	If the OAT rises above this setpoint, the economizer output will be set to the defined minimum position.
(OL) OAT Low Limit	If the OAT falls below this setpoint, the economizer output will be set to the defined minimum position.
(EM) Minimum Position	Specifies this minimum position for the economizer output when OAT rises or falls below the high and low limits
(ED) Economizer Staging Delay	Specifies how many minutes the controller will wait before using additional cooling stages after the economizer damper reaches 100%
(CM) Calculated Minimum Position	Displays the actual minimum position as calculated by the Economizer's internal control loop.
(MV) Reset Variable	Specifies an input for reset applications.
(MP) Reset Setpoint	Specifies the setpoint at which reset action occurs.
(MR) Maximum Reset	Specifies the maximum amount to reset the minimum position by when the variable reaches setpoint.
(ML) Reset Limit	Applied to determine the minimum position when (ML) is equal to the reset variable's input value.

5.11 PID CONTROL

The SBC-ASC(e) provides up to four (4) PID Control Loops for proportional control strategies. While some of these loops may be utilized by other strategies (such as Economizer or Valve Control - application dependent), the PID Control Loops can be used to control proportional equipment in an efficient manner.

Each PID Control is statically linked to a specific Analog Output. For example, PID Control 1 is linked to Analog Output 1, PID Control 2 is linked to Analog Output 2, etc.

The following section discusses the operation and configuration of PID Control in the SBC-ASC(e).

Table 5-12: PID Control Attributes

Attribute	Value and Interpretation
(SP) Loop Setpoint	Specifies the setpoint for loop control. The setpoint corresponds to the input variable specified in (IC) Input Channel
(CS) Control Setpoint	Indicates the current setpoint used as part of the control loop, displays the calculated setpoint with any setup/ setback, or setpoint adjustment from a connected SBC-STAT that may be applied.
(PO) Percent Output	Indicates the scaled output as configured in the actual Analog Output (FD0x).
(IN) Input Channel Value	Indicates the current value of the input variable specified in (IC) Input Channel .
(IC) Input Channel	Specifies the input reference that the loop will proportionally control by. Valid options include: 0 = Disable 1 = Zone Temperature 2 = Supply Temperature 4 = UI1 5 = UI2 6 = UI3 7 = UI4 8 = UI5 9 = Zone Heating (follows adjusted heating setpoint) 10 = Zone Cooling (follows adjusted cooling setpoint) 11 = Outside Air Temperature 13 = Relative Humidity
(MR) Maximum Reset	Specifies the maximum amount needed to reset to e loop setpoint based on when reset is being used.
(RC) Reset Variable Value	Indicates the current value of the reset variable specified in (RV) Reset Variable .

Table 5-12: PID Control Attributes

Attribute	Value and Interpretation
(RV) Reset Variable	Specifies the reset input reference that the loop will use to perform reset control. Valid options for reset include: 0 = Disable 1 = Zone Temperature 2 = Supply Temperature 4 = UI1 5 = UI2 6 = UI3 7 = UI4 8 = UI5 11 = Outside Air Temperature 13 = Relative Humidity
(RS) Reset Setpoint	Specifies the setpoint at which reset action begins. When the reset variable's value exceeds this setpoint, reset action will be used to determine the (CS) Control Setpoint .
(RL) Reset Limit	Specifies the value at which maximum reset is applied, based on the reset variable's value.
(DB) Deadband	Specifies the deadband for proportional control. The deadband straddles the setpoint. For example, a value of 2.0 would be applied to both the left and right side of the action.
(PB) Proportional Band	Specifies the variable range over which the output is changed based on input variable changes. The proportional band is centered around the setpoint for the loop.
(RP) Reset Period	Specifies the amount of time, in seconds, over which error history is accumulated for reset control.
(RT) Rate	Specifies the derivative rate for the loop
(CS) Control Sign	Specifies control action of the loop 0 = Normal/Direct, 1 = Reverse.
(SU) Setup/Setback	Specifies how much the setpoint should be lowered during unoccupied periods.
(ID) Interlock Enable/Disable	Enabled/Disables interlock failure modes for the control loop.
(P1) Interlock 1 Position	Fail position for the control loop when Interlock 1 occurs
(P2) Interlock 2 Position	Fail position for the control loop when Interlock 2 occurs
(P3) No Flow Position	Fail position if no flow or fan operation occurs.
(CE) Control Enable	Activation point for the control loop. To enable the loop, set to a value of 1(Yes).

5.12 SCHEDULING

Scheduling controls the current temperature setpoint of the SBC-ASC(e). There are multiple ways scheduling can be performed in the controller.

5.12.1 WEEKLY SCHEDULING

The SBC-ASC(e) contains six (6) Schedule channels, all of which are capable of performing 4-mode scheduling (Occupied, Unoccupied, Warmup, and Night Setback) for all days of the week including Holiday. Schedules can be cascaded to allow multiple occupancy periods for a specific day of week. Additionally, schedule channels can be configured for 24-hour operation using the **(AO) All Day Override** attribute.

To configure a Schedule channel, perform the following steps:

1. Using SoloPro, access *Schedules*>1, 2, 3, 4, 5, 6 (dependent on Schedule selection)
2. Set **(AD) Active Days** for each day that the schedule should follow
3. Set **(WO) Warmup Time**; **(OC) Occupied Time**; **(UN) Unoccupied Time**; and **(NS) Night Setback Time** for the times that the Schedule should enter into each occupancy state.
4. If you prefer that your schedule to operate in a single mode for an entire day, set **(AO) All-Day Override** to the desired schedule mode. The days selected on **(AD) Active Days** will operate to the setting of **(AO) All-Day Override**.

5.12.2 HOLIDAY CALENDAR

The SBC-ASC(e) contains ten (10) programmable attributes which can define days of the year that the controller should be consider as a holiday. These attributes are found in the F900 channel. They can be located in SoloPro at *Schedule*>*Clock/Calendar*. The attributes are **(H0)** through **(H9)**.

If the current date equals the value of one of the 10 programmable attributes, any schedule whose **(AD) Active Days** has its Holiday bit enabled, the Schedule will operate as defined.

5.12.3 BROADCAST SCHEDULE

The Broadcast Schedule is a schedule sent out over the network by another controller such as an SBC-GPC. The active internal schedule will be overridden if the SBC-ASC(e) is configured to receive network broadcast schedules. If the F005;**(RB) Receive Broadcast** property is enabled, the current schedule will reflect the F005;**(CV) Current Value** property. To configure the SBC-ASC(e) to receive network broadcast schedules:

1. Using SoloPro, access *Network*>*Schedule Broadcast*
2. Set **(RB) Receive Broadcast** = 1 (Yes)

5.12.4 POWER-UP STATE

If an unscheduled power loss occurs and power is restored, or if a soft reset of the controller is performed (FF00;**(RS) Reset Controller** = 1), the controller will operate in the schedule mode defined by the user in the **Power-up State** (FF00; **(PS) Power Up State**) attribute until a time synchronization received by the device from a time master. To set the schedule mode in which you want the device to operate upon power restoration or after a soft reset has occurred, select the value that corresponds to the desired power-up state. The possible states are listed in Table 5-13.

Table 5-13 : Power-up States

value	Power-Up State
0	Unoccupied
1	Warm-up

Table 5-13 : Power-up States

value	Power-Up State
2	Occupied
3	Night Setback

5.12.5 HOST OVERRIDE

In multi-device or zone situations, it may be advantageous to have a host or other peer device directly control the schedule state of the controller without broadcasts. In this case, the controller has a Host Override function in the Schedule Summary (F900) that can be utilized.

To configure the device to have its schedule controlled by an external source, set F900; **(HE) Host Override Local Schedules = 1** (Yes). Once set, the schedule of the device is then controlled through writes to the F900;**(HO) Host Schedule Setting** attribute.

The schedule mode set in **HO** will be the active mode unless:

- . a broadcast is received
- . an occupancy sensor is properly configured and occupancy is detected
- . user override occurs

5.13 SBC-STAT CONFIGURATION

The SBC-ASC(e) supports SBC-STAT model devices, as referenced in Section 2. There are a few configuration options available for a connected SBC-STAT, which this section reviews

5.13.1 SETPOINT ADJUSTMENT CONFIGURATION

Setpoint adjustment configuration can be achieved by accessing *Temperature>Setpoint Adjust* using SoloPro. Options found in this section include the following in the table below:

Table 5-14: Setpoint Adjustment Attributes

Attribute	Value and Interpretation
(ZS) Zone Midpoint	Specifies the comfort level for the zone.
(TS) User Setpoint Offset	Specifies an offset to apply to Zone Heating and Zone Cooling for PID Control.
(TM) User Adjust Increment	Specifies the magnitude of increment/decrement changes made to the setpoint.
(TT) User Adjust Duration	Specifies how much time, in minutes, a setpoint change is applied to the controller.
(SD) Calculated Setpoint Display	Specifies whether the offset, zone midpoint, heating setpoint, or cooling setpoint is displayed when a user performs setpoint adjustment.

5.13.2 USER OVERRIDE

If the active schedule controlling the SBC-ASC(e) is in unoccupied or night setback mode, user override is possible. If the user presses the up or down arrow push-button on the SBC-STAT2, SBC-STAT2D, or SBC-STAT3 and the FE00;(SE) **Override Enable/Disable** attribute is Enabled (value of 1), the unit will go into occupied mode.

The duration of this mode, which is also called extended occupancy, can be set by using the Zone Temperature:(ED) **Extended Occupancy Duration** property.

To configure the SBC-ASC(e) for user override ability via an SBC-STAT, perform the following steps:

1. Using SoloPro, access *Thermostat>Override*
2. Set **(SE) User Override** = 1 (Enabled)
3. Set **(ED) Extended Occupancy Duration** to however many minutes you wish for user override mode to occur.

When the unit's schedule is in unoccupied mode and the user enables override from a connect STAT, occupancy will occur for the amount of minutes specified in **(ED) Extended Occupancy Duration**. Once the time has elapsed, the unit will revert back to its configured schedule mode.

5.14 OCCUPANCY DETECTION

The occupancy detection feature enables the SBC-ASC(e) to automatically go to occupied mode, (also called extended occupancy) when a dedicated occupancy sensor indicates the monitored zone is occupied. The length of time that the controller will operate in extended occupancy is defined by the user in the FC01; **(MT) Extended Occupancy Duration** attribute. To configure the controller for occupancy detection capability, perform the following steps:

1. Using SoloPro, access *Aux>Occupancy Detector*
2. Set **(IC) Status Input** to the input that the occupancy detector is connected to.
3. Set **(MD) Extended Occupancy Delay** to the desired number of seconds the detector must indicate that occupancy is detected before overriding the zone. This prevents false triggering of the occupancy detection in the event someone or something quickly passes through the zone.
4. Set **(MT) Extended Occupancy Duration** to the desired number of minutes the controller is to remain in occupied mode once the zone has been occupied.

NOTE



If **(MT) Extended Occupancy Duration** is not set to a value greater than zero, the controller will not enter extended occupancy when it is detected that the zone is occupied.

NOTE



The input selected for the Occupancy Detection application must be configured as a digital input.

5.15 PULSE COUNTING

The SBC-ASC(e) provides an optically isolated digital input, which can be used for pulse counting. A Pulse application is provided, allowing users to perform count applications. To setup Pulse Counting, perform the following:

1. Using SoloPro, access *Aux>Pulse (OIA/OIB)*
2. Select a valid count mode from **(MD) Counter Mode**.
3. Enter your scale factor into **(SF) Pulse Scale Factor**

Your scaled value based on the number of pulses collected will appear in **(SV) Pulse Scale Value**.

SECTION 6: FANCOIL CONFIGURATION

The following section provides configuration details regarding the SBC-ASC(e) Fancoil application. Please review the following sections carefully prior to configuring the controller.

IN THIS SECTION

Fancoil Sequence Overview	6-3
Selecting Your Application Mode	6-4
Universal Input Configuration.....	6-5
Sensor Configuration	6-5
Universal Input Alarming.....	6-7
Supply & Outside Temperature Configuration.....	6-9
Supply/Discharge Temperature.....	6-9
Outside Air Temperature	6-9
Outside Air Temperature Broadcasts	6-9
Output Configuration	6-10
Fan Control	6-11
Fan Attributes.....	6-11
Fan Status.....	6-11
Electric Reheat.....	6-12
Electric Reheat Attributes	6-12
Valve Control.....	6-13
Valve Control Attributes.....	6-13
Economizer	6-15
PID Control	6-16
Scheduling	6-18
Weekly Scheduling.....	6-18
Holiday Calendar	6-18
Broadcast Schedule.....	6-18
Power-up State.....	6-18
Host Override.....	6-19
SBC-STAT Configuration	6-20
Setpoint Adjustment Configuration	6-20
User Override.....	6-20
Occupancy Detection.....	6-21
Pulse Counting.....	6-22

6.1 FANCOIL SEQUENCE OVERVIEW

The Fancoil application of the SBC-ASC(e) provides standard fancoil control utilizing zone temperature control with integrated (optional) outside air temperature and supply temperature (discharge temp) mediation. The fan can be configured for single speed or multi-speed (up to 3 speeds max), include stages of electric reheat, as well as valve control options for additional heating and cooling with integrated changeover.

- . Five (5) Universal Inputs - configurable for:
 - . Outside Air Temp & Discharge Air Temp Sensors
 - . Occupancy Detection Sensor
 - . Proof of Flow Sensing
 - . General Purpose Input Sensing
- . Five (5) Binary Outputs
 - . Fan configurable for up to three fan speeds (BO1 = Low, BO2 = Medium, BO3 = High)
 - . Electric reheat application with supply temperature lockout capabilities
- . Valve Control
 - . Can utilize un-used pairs of binary outputs (BO2/BO3 or BO4/BO5)
 - . Can utilize an available PID Control Loop
 - . Provides changeover control for heating and cooling with setpoints and definable input
 - . Outside Air Temperature and Discharge Air Temperature Lockout
 - . Configurable loop parameters
- . Up to Four (4) dedicated PID Control sequences for proportional control
 - . Each PID Control Loop is internally connected to a respective Analog Output (PID1 -> AO1, etc.)
 - . PID Control Loops have several input variables including all inputs, and user adjust setpoints
 - . PID Control Loops have several reset variables including all inputs, and user adjust setpoints
 - . Interlock failure positioning
- . Outside Air Temperature-based economizer control
 - . Based on the input selected for Outside Air Temperature
 - . Utilizes an available PID Control Loop
 - . Provides minimum position control, staging delay, lockouts, and reset setpoint and limiting

The SBC-ASC(e) also provides the following features:

- . Configurable Heating and Cooling Setpoints
 - . Includes defined setbacks for unoccupied and night setback schedule modes
- . Input Alarming
 - . Analog or Digital Alarming on all inputs (except opto-isolated digital input)
- . Weekly Schedule with four modes (Warmup, Occupied, Unoccupied, Night Setback)
 - . Can be used for days of week or multiple days of week
 - . Up to 10 specific dates can be defined for holiday modes (intended for stand-alone operation)
 - . All day override options for 24-hour control of specific days of the week
 - . Host Override of Schedule control - allowing global controllers to force the unit into a mode
- . Occupancy Detection
 - . Assignable by Universal Input selection
 - . Definable delays and duration timing for occupancy controlled units.
- . Pulse Counting
 - . Utilizes the opto-isolated digital input
 - . Can be configured to count rising edges, falling edges, or both
 - . Configurable factor and scale values.

6.2 SELECTING YOUR APPLICATION MODE

Prior to configuring equipment such as heating and cooling stages, you should first define the application mode that the Fancoil will conform to. There are three different application modes that the Fancoil can perform. They are as followed:

- . Cooling Only - utilizes cooling only routines and optional economizer control. Optionally uses PID Control for other miscellaneous control applications carried out.
- . Heating Only - utilizes heating only routines and optional economizer control. Optionally uses PID Control for other miscellaneous control applications carried out.
- . Supply Dependent (VST) - performs both heating and cooling. Optionally uses PID Control for other miscellaneous control applications carried out.
- . Cooling with Reheat - performs cooling with electric reheat

To configure your application mode, perform the following steps:

1. Using SoloPro, access *Temperature>Thermostat*
2. Locate **(BT) Control Mode**
3. For Cooling Only, set **(BT) Control Mode = 1** (Cooling Only)
4. For Heating Only, set **(BT) Control Mode = 2** (Heating Only)
5. For Heating & Cooling, set **(BT) Control Mode = 3** (Supply Dependent)
6. For Cooling w/ Reheat, set **(BT) Control Mode = 4** (Cooling w/Reheat)

6.3 UNIVERSAL INPUT CONFIGURATION

Universal Inputs permit the configuration of multiple sensor types, dependent on your application. The SBC-ASC(e) also supports alarm capabilities within its Universal Inputs. The following section provides a quick-start reference for initial configuration of inputs, as well as alarming. Complete information regarding each property available within Universal Inputs can be located in Section 5.

6.3.1 SENSOR CONFIGURATION

The following section discusses how to configure a Universal Input for a specific sensor type. Universal Input configuration includes modifying control logic programming inside the SBC-ASC(e) using SoloPro and IVR hardware jumper configuration. The IVR jumpers are located above the Universal Input terminal blocks on the top right-hand side of the unitary controller, as illustrated in Figure 6-1.

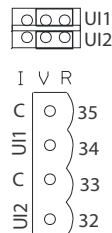

Figure 6-1 Universal Input IVR Jumper Location

6.3.1.1 DIGITAL INPUTS

To setup an input as a digital sensor, you must first configure the IVR jumper to VR, which places the input into a resistance setting.

In SoloPro, access *IO Setup>Universal Inputs> 1, 2, 3, 4, 5* (dependent on the UI), and set **(ST) Sensor Type** = 0 (Digital). Verify that **(OI) Override Input** = 0 (No) to assure that the value displayed in **(CV) Current Value** is the actual reading from the sensor. If **(RE) Channel Reliability** displays a value other than (0) Reliable, verify input wiring.

Table 6-1: Summary of Digital Input Configuration

Channel	Attribute	Value	Description
FE0x	(ST) Sensor Type	0	Digital sensor configuration
	(RE) Channel Reliability	0 (Reliable)	Input set to automatic mode

6.3.1.2 LINEAR SENSORS (0-10VDC)

To setup an input for a 0-10VDC sensor, completely remove the IVR jumper to configure the UI for voltage mode.

In SoloPro, access *IO Setup>Universal Inputs> 1, 2, 3, 4, 5* (dependent on the UI), and set **(ST) Sensor Type** = 2 (Linear). Configure **(MN) Minimum Scaled Value** and **(MX) Maximum Scaled Value** to the

minimum and maximum scaled values for **(CV) Current Value** is the actual reading from the sensor. Verify that **(OI) Override Input** = 0 (No) to assure that the value displayed in **(CV) Current Value** is the actual reading from the sensor. If **(RE) Channel Reliability** displays a value other than (0) Reliable, verify input wiring.

Table 6-2: Summary of an Example Linear Input Configuration

Channel	Attribute	Value	Description
UI0x	(ST) Sensor Type	2 (Linear)	Linear sensor configuration
	(MN) Minimum Scaled Value	0	Lowest present-value scale reading for the target sensor
	(MX) Maximum Scaled Value	100	Highest present-value scale reading for the target sensor
	(OI) Override Input	0 (No)	Input set to automatic mode

6.3.1.3 4-20mA SENSORS

To setup an input as a 4-20mA sensor, you must first configure the IVR jumper to IV, which places the input into a voltage setting.

In SoloPro, access *IO Setup>Universal Inputs> 1, 2, 3, 4, 5* (dependent on the UI), and set **(ST) Sensor Type** = 3 (4-20mA). Configure **(MN) Minimum Scaled Value** and **(MX) Maximum Scaled Value** to the minimum and maximum scaled values for **(CV) Current Value** is the actual reading from the sensor. Verify that **(OI) Override Input** = 0 (No) to assure that the value displayed in **(CV) Current Value** is the actual reading from the sensor. If **(RE) Channel Reliability** displays a value other than (0) Reliable, verify input wiring.

Table 6-3: Summary of an Example 4-20mA Input Configuration

Channel	Attribute	Value	Description
UI0x	(ST) Sensor Type	3	4-20mA sensor configuration
	(MN) Minimum Scaled Value	0	Lowest present-value scale reading for the target sensor
	(MX) Maximum Scaled Value	100	Highest present-value scale reading for the target sensor
	(OI) Override Input	0 (False)	Input set to automatic mode

6.3.1.4 THERMISTOR INPUT

To setup an input for thermistor readings, you must first configure the IVR jumper to VR, which places the input into a resistance setting.

In SoloPro, access *IO Setup>Universal Inputs> 1, 2, 3, 4, 5* (dependent on the UI), and set **(ST) Sensor Type** = 7 (Thermistor). Configure the minimum and maximum scaled values for **(CV) Current Value** is the

actual reading from the sensor. Verify that **(OI) Override Input** = 0 (No) to assure that the value displayed in **(CV) Current Value** is the actual reading from the sensor. If **(RE) Channel Reliability** displays a value other than (0) Reliable, verify input wiring.

Table 6-4: Summary of Thermistor Input Configuration

Channel	Attribute	Value	Description
UI0x	(ST) sensor type	7 (Thermistor)	Thermistor sensor configuration
	(OI) Override Input	0 (False)	Input set to automatic mode

6.3.1.5 ANALOG SBC-STAT1

To setup an input for temperature readings from an Analog SBC-STAT1, you must first configure the IVR jumper to VR, which places the input into a resistance setting.

In SoloPro, access *IO Setup>Universal Inputs> 1, 2, 3, 4, 5* (dependent on the UI), and set **(ST) Sensor Type** = 8 (Analog STAT1). Verify that **(OI) Override Input** = 0 (No) to assure that the value displayed in **(CV) Current Value** is the actual reading from the sensor. If **(RE) Channel Reliability** displays a value other than (0) Reliable, verify input wiring.

Table 6-5: Summary of Analog STAT1 Configuration

Channel	Attribute	Value	Description
UI0x	(ST) sensor type	8 (STAT1)	Analog STAT1 sensor configuration
	(OI) Override Input	0 (False)	Input set to automatic mode

6.3.2 UNIVERSAL INPUT ALARMING

The inputs supports general alarming conditions such as Off/On, On/Off, Change of State for digital sensors, and basic high/low limit alarming for analog sensors. To configure alarming, perform the following steps:

1. With your input configured set **(AE) Alarm Enable** to the specific alarming application desired.
2. For low limit alarms, configure **(LL) Low Alarm Limit** to the limit by which the value of your input must fall below before an alarm event is generated.
3. For high limit alarms, configure **(HL) High Alarm Limit** to the limit by which the value of your input must exceed before an alarm event is generated.

Table 6-6: Alarm Application Details

Value of AE	Alarm Condition
AE=0 (default)	disabled
AE=1	contact, 0→1

Table 6-6: Alarm Application Details

Value of AE	Alarm Condition
AE=2	contact, 1→0
AE=3	change of state, 1↔0
AE=4	low limit alarm
AE=5	high limit alarm

6.4 SUPPLY & OUTSIDE TEMPERATURE CONFIGURATION

The following section reviews configuration of the Supply and Outside Air Temperature sensors within the Fancoil application.

6.4.1 SUPPLY/DISCHARGE TEMPERATURE

The Fancoil application can utilize supply temperature for heating/cooling lockout, as well as integrated supply control. Configuring this area is mandatory to make certain that stages of heating and cooling are or are not locked out. If your application does not require this temperature sensor, set **(OI) Override Supply Temperature** = 1 (Yes), located in *Temperature>Supply*.

If your application does involve integration of supply sensing, perform the following steps:

1. In SoloPro, access *Temperature>Supply*
2. Verify **(OI) Override Supply Temperature** = 0 (No)
3. Set **(IC) Supply Temperature Source** to the Universal Input your Supply Temperature sensor is connected to.
4. Set **(DD) Auto Mode Deadband** to a realistic value. The Auto Mode Deadband specifies the temperature difference by which the supply air must either exceed the heating setpoint to engage heating mode or fall below the cooling setpoint to engage cooling mode. A value of 0.0 will disable supply deadband control over heating and cooling modes. This attribute is commonly used when your application has been configured for Supply Dependent mode.

6.4.2 OUTSIDE AIR TEMPERATURE

The Fancoil application utilizes outside air temperature for locking out heating and cooling stages, as well as for operating the Economizer routine. Configuring this area is mandatory to make certain that stages of heating and cooling are or are not locked out. If your application does not require this temperature sensor, set **(OI) Override Supply Temperature** = 1 (Yes) located in *Temperature>Outside*

If your application does involve integration of supply sensing, perform the following steps:

1. In SoloPro, access *Temperature>Outside*
2. Verify **(OI) Override Outside Temperature** = 0 (No)
3. Set **(IC) Outside Temperature Source** to the Universal Input your Outside Air Temperature sensor is connected to.

6.4.3 OUTSIDE AIR TEMPERATURE BROADCASTS

The Fancoil application can receive an Outside Air Temperature broadcast from another unit that is configured to perform broadcasting (such as an SBC-GPC). Additionally, the unit can also send a broadcast if desired. To receive or send Outside Air Temperature, perform the following steps:

1. In SoloPro, access *Network>OAT Broadcast*.
2. To receive a broadcast Outside Air Temperature, set **(RB) Receive Broadcast** = 1 (Yes).
3. To send Outside Air Temperature broadcasts, set **(BE) Broadcast Enable** = 1 (Yes).

6.5 OUTPUT CONFIGURATION

In order for outputs to be manipulated by any of the control strategies in the controller, all of the outputs (both Analog and Binary) must be configured for automatic control.

To configure Analog Outputs, perform the following steps:

1. Using SoloPro, access I/O Setup>Analog Outputs (AO1 - AO4).
2. For each Analog Output, set (AM) Control Mode = 1 (Automatic).
3. Minimum and Maximum Scaled Voltages and Engineering Units can be assigned here as well.

When Analog Outputs are configured for manual mode, they cannot be manipulated by any of the internal control processes. However, the Analog Output can be manually written to.

To configure Binary Outputs, perform the following steps:

1. Using SoloPro, access I/O Setup>Relay Outputs (K1 - K5).
2. For each Binary Output, set (OI) Override = 2 (Auto).
3. Output polarity may also be configured in this section.

6.6 FAN CONTROL

The Fancoil application can be configured for single speed, 2-speed, or 3-speed fan control based on the type of unit you are working with. The following section reviews configuration for the following items:

- . Fan Attributes
- . Fan Status

6.6.1 FAN ATTRIBUTES

To configure the Fan Attributes, perform the following steps:

1. In SoloPro, access *Equipment> Fan*
2. Configure all properties accordingly.

Table 6-7: Fan Attributes Details

Attribute	Value and Interpretation
(SP) Fan Speeds	Specifies the number of fan speeds which will be utilized (1, 2, or 3)
(CS) Fan Set Speed	This attribute is a network point intended for use of graphical user interfaces to allow end-users to control the fan speed.
(FD) Shutoff Delay	The amount of time in seconds that the fan will remain on after all stages of cooling have been de-energized.
(FO) Occupied Mode	0 (Auto) - Fan turns off and off only when needed as defined by heating and cooling setpoints 1 (On) - Fan is always on.
(FU) Unoccupied Mode	0 (Auto) - Fan turns off and off only when needed as defined by heating and cooling setpoints 1 (On) - Fan is always on.
(FN) Night Setback Mode	0 (Auto) - Fan turns off and off only when needed as defined by heating and cooling setpoints 1 (On) - Fan is always on.

6.6.2 FAN STATUS

Fan Status is used to track the actual status of the fan output through use of a proof of flow sensor connected to a universal input or even the opto-isolated digital input. If you use a proof of flow sensor and the flow status does not match the output status, stages of heating and cooling will be locked out.

To configure Fan Status, perform the following steps:

1. Using SoloPro, access *Aux>Fan Status*
2. Select the input where your proof of flow sensor it attached using (IC) Status Input.
3. Enter a delay value **(PD) Delay**. This will impose a delay before considering a positive flow indication.

6.7 ELECTRIC REHEAT

The Fancoil application can be configured to utilize stages of electric reheat. Dependent on your fan speed configuration, the controller can utilize two-stage electric reheat using output pairs BO2/BO3 (FB02/FB03) and BO4/BO5 (FB04/FB05). For single speed fan application, you can also utilize four-stage electric reheat using Binary Outputs 2 through 5. The following section reviews configuration for the following items:

- Electric Reheat Attributes

6.7.1 ELECTRIC REHEAT ATTRIBUTES

To configure the Electric Reheat Attributes, perform the following steps:

- In SoloPro, access *Equipment>Electric Reheat*
- Configure all properties accordingly.

Table 6-8: Electric Reheat Attributes Details

Attribute	Value and Interpretation
(RO) Reheat Mode	Used to configure the electric reheat application for use with the controller. 0 = Disabled 1 = 2-stage (K2/K3) 2 = 2-stage (K4/K5) 3 = 4-stage (K2/K3/K4/K5)
(FR) Stages Requiring Flow	Specifies which stages require a proof of flow indication prior to engaging.
(AF) Require Max Airflow	Typically set for No
(MX) Max Supply Temp	Specifies the maximum supply temperature above which reheats will de-energize/lockout
(BA) Balance Stage Usage	When set to 1 (Yes), the controller will balance stage usage by comparing run hour totals from each output. Stages with lower run hours will be energized first.
(OF) Reheat Offset	Specifies, in degrees, the offset from the calculated heating and cooling setpoints that determine when staging occurs.
(ID) Stage Delay	Specifies the amount of time, in minutes, between stage energizing.

6.8 VALVE CONTROL

Valve Control can be used to provide additional heating and cooling capabilities with changeover control for heating and cooling. Valve control can be configured to use paired binary outputs, or utilize an available PID Control Loop.

Table 6-9: Valve Control Output Assignment Configuration

(VM) Valve Mode	Output Strategy
Pulse Width Modulation or Floating Point Motor Control	Valve Control 1 - FA08 K2 (close) / K3 (open) Valve Control 2 - FA09 K4 (close) / K5 (open)
PID 1	PID Control 1 / Analog Output 1
PID 2	PID Control 2 / Analog Output 2
PID 3	PID Control 3 / Analog Output 3
PID 4	PID Control 4 / Analog Output 4

The following section reviews configuration for the following items:

- Valve Control Attributes

6.8.1 VALVE CONTROL ATTRIBUTES

To configure Valve Control Attributes, perform the following:

To configure the Electric Reheat Attributes, perform the following steps:

- In SoloPro, access *Equipment>Valve Control*
- Configure all properties accordingly.

Table 6-10: Valve Control Attributes Details

Attribute	Value and Interpretation
(VU) Valve Use	Specifies the use for the valve 0 = Disabled 1 = Cooling 2 = Heating
(VM) Valve Mode	Defines how the valve is physically controlled. 0 = Pulse With Modulation 1 = Floating Point Motor Control 2 = PID 1 3 = PID 2 4 = PID 3 5 = PID 4
(UT) Update Threshold	Defines how often the desired valve position is updated and is used to minimize the actuation of the valve for insignificant changes.

Table 6-10: Valve Control Attributes Details

Attribute	Value and Interpretation
(RI) Re-calibration Interval	Specifies the amount of time, in hours, between valve re-calibration periods. The valve is re-calibrated by driving the valve in the closed direction for the full travel time, then restoring the desired position.
(VO) Valve Offset	Added/Subtracted from the heating and cooling setpoints to determine the setpoint for the loop.
(VP) Valve Proportional Band	Specifies the amount of degrees over which the output valve is proportional to the error. The proportional band is offset from the setpoint (determined by VO)
(VI) Valve Integration Constant	Specifies the amount of error history (0 to 25.5%) used to calculate the desired position of the valve
(VT) Valve Travel Time	Specifies the amount of time, in seconds, it takes the valve motor to travel from fully closed to fully open.
(PP) Pulse Duration Period	Specifies the amount of time, in seconds, the valve is pulsed on when the loop is using Pulse Width Modulation as the configured Valve Mode.
(CD) Change Valve Direction	Specifies the direction of the valve.
(TL) DAT Low Temp Lockout	Specifies the lowest supply temperature reading permitted before cooling control is locked out.
(CL) OAT Cooling Lockout	Specifies the lowest outside air temperature reading permitted before cooling control is locked out.
(TH) DAT High Temp Lockout	Specifies the highest supply temperature reading permitted before heating control is locked out.
(HL) OAT Heating Lockout	Specifies the highest outside air temperature reading permitted before heating control is locked out.
(AM) Auto/Manual	Used to enable or disable control
(CC) Changeover Control Input	Indicates the input monitored for heating/cooling changeover
(CS) Changeover Cool Setpoint	Specifies a temperature below which the valve operation will switch to cooling mode
(HS) Changeover Heat Setpoint	Specifies a temperature above which the valve operation will switch to heating mode

6.9 ECONOMIZER

The Fancoil application includes an Economizer. Based on outside air temperature, the economizer can be configured to open a damper during calls for cooling to provide free cooling, allowing the space to cool down using cooler outside air as an alternative to running all stages of cooling. The economizer can utilize an available second stage of heating or cooling, or use one of the four PID control loops to control a proportional motor.

To use the economizer, your Outside Air Temperature sensor must be configured (see previous steps). To configure the economizer, perform the following steps:

1. Using SoloPro, access *Aux>Economizer*
2. Configure your attributes accordingly.

Table 6-11: Economizer Attribute Details

Attribute	Value and Interpretation
(EE) Economizer Enable	Specifies the PID Loop or Binary Output to be used for Economizer control. 0 = Disabled 1 = PID 1 (FA11) 2 = PID 2 (FA12) 3 = PID 3 (FA13) 4 = PID 4 (FA14) 5 = BO3 (FB03) 6 = BO5 (FB05) Note - Using BO3 or BO5 will cancel out the second stage of heating or cooling respectively.
(OH) OAT High Limit	If the OAT rises above this setpoint, the economizer output will be set to the defined minimum position.
(OL) OAT Low Limit	If the OAT falls below this setpoint, the economizer output will be set to the defined minimum position.
(EM) Minimum Position	Specifies this minimum position for the economizer output when OAT rises or falls below the high and low limits
(ED) Economizer Staging Delay	Specifies how many minutes the controller will wait before using additional cooling stages after the economizer damper reaches 100%
(CM) Calculated Minimum Position	Displays the actual minimum position as calculated by the Economizer's internal control loop.
(MV) Reset Variable	Specifies an input for reset applications.
(MP) Reset Setpoint	Specifies the setpoint at which reset action occurs.
(MR) Maximum Reset	Specifies the maximum amount to reset the minimum position by when the variable reaches setpoint.
(ML) Reset Limit	Applied to determine the minimum position when (ML) is equal to the reset variable's input value.

6.10 PID CONTROL

The SBC-ASC(e) provides up to four (4) PID Control Loops for proportional control strategies. While some of these loops may be utilized by other strategies (such as Economizer or Valve Control - application dependent), the PID Control Loops can be used to control proportional equipment in an efficient manner.

Each PID Control is statically linked to a specific Analog Output. For example, PID Control 1 is linked to Analog Output 1, PID Control 2 is linked to Analog Output 2, etc.

The following section discusses the operation and configuration of PID Control in the SBC-ASC(e).

Table 6-12: PID Control Attributes

Attribute	Value and Interpretation
(SP) Loop Setpoint	Specifies the setpoint for loop control. The setpoint corresponds to the input variable specified in (IC) Input Channel
(CS) Control Setpoint	Indicates the current setpoint used as part of the control loop, displays the calculated setpoint with any setup/ setback, or setpoint adjustment from a connected SBC-STAT that may be applied.
(PO) Percent Output	Indicates the scaled output as configured in the actual Analog Output (FD0x).
(IN) Input Channel Value	Indicates the current value of the input variable specified in (IC) Input Channel .
(IC) Input Channel	Specifies the input reference that the loop will proportionally control by. Valid options include: 0 = Disable 1 = Zone Temperature 2 = Supply Temperature 4 = UI1 5 = UI2 6 = UI3 7 = UI4 8 = UI5 9 = Zone Heating (follows adjusted heating setpoint) 10 = Zone Cooling (follows adjusted cooling setpoint) 11 = Outside Air Temperature
(MR) Maximum Reset	Specifies the maximum amount needed to reset to e loop setpoint based on when reset is being used.
(RC) Reset Variable Value	Indicates the current value of the reset variable specified in (RV) Reset Variable .

Table 6-12: PID Control Attributes

Attribute	Value and Interpretation
(RV) Reset Variable	Specifies the reset input reference that the loop will use to perform reset control. Valid options for reset include: 0 = Disable 1 = Zone Temperature 2 = Supply Temperature 4 = U1 5 = U2 6 = U3 7 = U4 8 = U5 11 = Outside Air Temperature
(RS) Reset Setpoint	Specifies the setpoint at which reset action begins. When the reset variable's value exceeds this setpoint, reset action will be used to determine the (CS) Control Setpoint .
(RL) Reset Limit	Specifies the value at which maximum reset is applied, based on the reset variable's value.
(DB) Deadband	Specifies the deadband for proportional control. The deadband straddles the setpoint. For example, a value of 2.0 would be applied to both the left and right side of the action.
(PB) Proportional Band	Specifies the variable range over which the output is changed based on input variable changes. The proportional band is centered around the setpoint for the loop.
(RP) Reset Period	Specifies the amount of time, in seconds, over which error history is accumulated for reset control.
(RT) Rate	Specifies the derivative rate for the loop
(CS) Control Sign	Specifies control action of the loop 0 = Normal/Direct, 1 = Reverse.
(SU) Setup/Setback	Specifies how much the setpoint should be lowered during unoccupied periods.
(ID) Interlock Enable/Disable	Enabled/Disables interlock failure modes for the control loop.
(P1) Interlock 1 Position	Fail position for the control loop when Interlock 1 occurs
(P2) Interlock 2 Position	Fail position for the control loop when Interlock 2 occurs
(P3) No Flow Position	Fail position if no flow or fan operation occurs.
(CE) Control Enable	Activation point for the control loop. To enable the loop, set to a value of 1(Yes).

6.11 SCHEDULING

Scheduling controls the current temperature setpoint of the SBC-ASC(e). There are multiple ways scheduling can be performed in the controller.

6.11.1 WEEKLY SCHEDULING

The SBC-ASC(e) contains six (6) Schedule channels, all of which are capable of performing 4-mode scheduling (Occupied, Unoccupied, Warmup, and Night Setback) for all days of the week including Holiday. Schedules can be cascaded to allow multiple occupancy periods for a specific day of week. Additionally, schedule channels can be configured for 24-hour operation using the **(AO) All Day Override** attribute.

To configure a Schedule channel, perform the following steps:

1. Using SoloPro, access *Schedules*>1, 2, 3, 4, 5, 6 (dependent on Schedule selection)
2. Set **(AD) Active Days** for each day that the schedule should follow
3. Set **(WO) Warmup Time**; **(OC) Occupied Time**; **(UN) Unoccupied Time**; and **(NS) Night Setback Time** for the times that the Schedule should enter into each occupancy state.
4. If you prefer that your schedule to operate in a single mode for an entire day, set **(AO) All-Day Override** to the desired schedule mode. The days selected on **(AD) Active Days** will operate to the setting of **(AO) All-Day Override**.

6.11.2 HOLIDAY CALENDAR

The SBC-ASC(e) contains ten (10) programmable attributes which can define days of the year that the controller should be consider as a holiday. These attributes are found in the F900 channel. They can be located in SoloPro at *Schedule*>*Clock/Calendar*. The attributes are **(H0)** through **(H9)**.

If the current date equals the value of one of the 10 programmable attributes, any schedule whose **(AD) Active Days** has its Holiday bit enabled, the Schedule will operate as defined.

6.11.3 BROADCAST SCHEDULE

The Broadcast Schedule is a schedule sent out over the network by another controller such as an SBC-GPC. The active internal schedule will be overridden if the SBC-ASC(e) is configured to receive network broadcast schedules. If the F005;**(RB) Receive Broadcast** property is enabled, the current schedule will reflect the F005;**(CV) Current Value** property. To configure the SBC-ASC(e) to receive network broadcast schedules:

1. Using SoloPro, access *Network*>*Schedule Broadcast*
2. Set **(RB) Receive Broadcast** = 1 (Yes)

6.11.4 POWER-UP STATE

If an unscheduled power loss occurs and power is restored, or if a soft reset of the controller is performed (FF00;**(RS) Reset Controller** = 1), the controller will operate in the schedule mode defined by the user in the **Power-up State** (FF00; **(PS) Power Up State**) attribute until a time synchronization received by the device from a time master. To set the schedule mode in which you want the device to operate upon power restoration or after a soft reset has occurred, select the value that corresponds to the desired power-up state. The possible states are listed in Table 6-13.

Table 6-13 : Power-up States

value	Power-Up State
0	Unoccupied
1	Warm-up

Table 6-13 : Power-up States

value	Power-Up State
2	Occupied
3	Night Setback

6.11.5 HOST OVERRIDE

In multi-device or zone situations, it may be advantageous to have a host or other peer device directly control the schedule state of the controller without broadcasts. In this case, the controller has a Host Override function in the Schedule Summary (F900) that can be utilized.

To configure the device to have its schedule controlled by an external source, set F900; **(HE) Host Override Local Schedules = 1** (Yes). Once set, the schedule of the device is then controlled through writes to the F900;**(HO) Host Schedule Setting** attribute.

The schedule mode set in **HO** will be the active mode unless:

- . a broadcast is received
- . an occupancy sensor is properly configured and occupancy is detected
- . user override occurs

6.12 SBC-STAT CONFIGURATION

The SBC-ASC(e) supports SBC-STAT model devices, as referenced in Section 2. There are a few configuration options available for a connected SBC-STAT, which this section reviews

6.12.1 SETPOINT ADJUSTMENT CONFIGURATION

Setpoint adjustment configuration can be achieved by accessing *Temperature>Setpoint Adjust* using SoloPro. Options found in this section include the following in the table below:

Table 6-14: Setpoint Adjustment Attributes

Attribute	Value and Interpretation
(ZS) Zone Midpoint	Specifies the comfort level for the zone.
(TS) User Setpoint Offset	Specifies an offset to apply to Zone Heating and Zone Cooling for PID Control.
(TM) User Adjust Increment	Specifies the magnitude of increment/decrement changes made to the setpoint.
(TT) User Adjust Duration	Specifies how much time, in minutes, a setpoint change is applied to the controller.
(SD) Calculated Setpoint Display	Specifies whether the offset, zone midpoint, heating setpoint, or cooling setpoint is displayed when a user performs setpoint adjustment.

6.12.2 USER OVERRIDE

If the active schedule controlling the SBC-ASC(e) is in unoccupied or night setback mode, user override is possible. If the user presses the up or down arrow push-button on the SBC-STAT2, SBC-STAT2D, or SBC-STAT3 and the FE00;(SE) **Override Enable/Disable** attribute is Enabled (value of 1), the unit will go into occupied mode.

The duration of this mode, which is also called extended occupancy, can be set by using the Zone Temperature:(ED) **Extended Occupancy Duration** property.

To configure the SBC-ASC(e) for user override ability via an SBC-STAT, perform the following steps:

1. Using SoloPro, access *Thermostat>Override*
2. Set **(SE) User Override** = 1 (Enabled)
3. Set **(ED) Extended Occupancy Duration** to however many minutes you wish for user override mode to occur.

When the unit's schedule is in unoccupied mode and the user enables override from a connect STAT, occupancy will occur for the amount of minutes specified in **(ED) Extended Occupancy Duration**. Once the time has elapsed, the unit will revert back to its configured schedule mode.

6.13 OCCUPANCY DETECTION

The occupancy detection feature enables the SBC-ASC(e) to automatically go to occupied mode, (also called extended occupancy) when a dedicated occupancy sensor indicates the monitored zone is occupied. The length of time that the controller will operate in extended occupancy is defined by the user in the FC01; **(MT) Extended Occupancy Duration** attribute. To configure the controller for occupancy detection capability, perform the following steps:

1. Using SoloPro, access *Aux>Occupancy Detector*
2. Set **(IC) Status Input** to the input that the occupancy detector is connected to.
3. Set **(MD) Extended Occupancy Delay** to the desired number of seconds the detector must indicate that occupancy is detected before overriding the zone. This prevents false triggering of the occupancy detection in the event someone or something quickly passes through the zone.
4. Set **(MT) Extended Occupancy Duration** to the desired number of minutes the controller is to remain in occupied mode once the zone has been occupied.

NOTE



If **(MT) Extended Occupancy Duration** is not set to a value greater than zero, the controller will not enter extended occupancy when it is detected that the zone is occupied.

NOTE



The input selected for the Occupancy Detection application must be configured as a digital input.

6.14 PULSE COUNTING

The SBC-ASC(e) provides an optically isolated digital input, which can be used for pulse counting. A Pulse application is provided, allowing users to perform count applications. To setup Pulse Counting, perform the following:

1. Using SoloPro, access Aux>Pulse (OIA/OIB)
2. Select a valid count mode from **(MD) Counter Mode**.
3. Enter your scale factor into **(SF) Pulse Scale Factor**

Your scaled value based on the number of pulses collected will appear in **(SV) Pulse Scale Value**.

APPENDIX A: ROOFTOP PUP CHANNELS AND ATTRIBUTES

The following tables contain a list of Public Unitary Protocol (PUP) attribute and channel assignments for the Rooftop application. Each attribute is given with its PUP channel assignment, PUP data type, access code, where it is stored, its SoloPro for Windows location and a brief description.

SYSTEM CHANNEL, FF00

FF00 Attr.	Data Type	Access	Store & Default	SP for Windows Location	Description
SR	FE	R	Flash	System/About	Flash Release Code uniquely defines each flash firmware image
TF	FE	RW	EE 0	System/Interlocks	Time in Fire number of minutes the SBC-ASC remains in fire mode upon receipt of a "Change Operation Mode" broadcast. If TF = 0, the SBC-ASC will remain in fire mode until the controller is reset. If TF = 255, then the SBC-ASC will not accept "Change of Mode" broadcasts.
TP	FE	RW	EE 0 Irresponsible Peers	Network/Configuration	Token Passing Type defines the mode for token passing. When a controller is an Irresponsible Peer it will always return a token to the device that passed it, after performing any pending transactions. In Full Administrator mode, the token is passed to each unit listed in the Peer List (FF00:U1 through FF00:U4). 0 = irresponsible peer 1 = full administrator
U1-U4	FE	RW	EE 65535	Network/Configuration	Peer Unit Number defines the Unit ID of a peer. In Full Administrator mode the token is passed to each unit in the Peer List.
UP	FE	R	0	System/Diagnostics	Flash Update Count increments each time a new flash firmware image is accepted by the controller.
VE	FA	R	Flash	System/About	Version Number contains the factory-set firmware version

FF00 Attr.	Data Type	Access	Store & Default	SP for Windows Location	Description
WC	FE	R	0	System/Diagnostics	Watchdog Count increments upon firmware failure but can also be advanced during the removal of power
ZN	FE	RW	EE 0	Network/Configuration	Zone Number from 0 to 65,535 used to group controllers so that they can be controlled simultaneously
ZP	FE	RW	0	System/Diagnostics	MMT Pulse Count advances when MMT takes action to maintain the operation of the actuator
BU	FE	RW	RAM 0	System/Power-up	Back Up RAM Values copies specific attribute values from RAM to EEPROM when set to 1: 0 = normal operation, 1 = back up RAM to EEPROM
CC	FE	RW	0	System/Diagnostics	Clock Fail Count increments upon hardware failure but can also be advanced during the removal of power
CM	FE	R	Flash 255	System/About	Controller Manufacturer contains the factory-set manufacturer number for the unitary controller
CP	FE	RW	EE 0	Network/Configuration	Communication Speed specifies the communication speed (baud rate) at which devices on this network will communicate 0=9600 1=4800 2=2400 3=1200 4=reserved 5=reserved 6=38.4K 7=19.2K 8=115.2K 9=57.6K

FF00 Attr.	Data Type	Access	Store & Default	SP for Windows Location	Description
CT	FE	R	Flash 101	System/About	Controller Type factory-set controller type identifies the type of unitary controller
DE	FE	RW	RAM	System/Power-up	Default Enable this attribute is used to restore configuration settings to factory defaults
EM	FE	RW	EE 0	System/About	English/Metric specifies which units of measurement to use in returning temperature and airflow values: 0 = English Units; 1 = Metric Units
ER	FE	RW	EE 0 Disabled	Network/Configuration	Token Recovery enables Token Recovery. In a token passing environment there should always be network activity, but if a token is lost the network will fall silent. If Token Recovery is enabled, and a token is lost, Full Administrator will detect the condition and initiate a new token. 0 = disabled 1 = enabled
FT	FE	R	Flash 4	System/About	Firmware Type defines the class of firmware operating system used in this controller
F1	FE	RW	EE 0	System/Interlocks	Fan Failure Interlock Trips Fan? When F1 is set to 0, Interlock 1 will not trip the fan. When set to 1 and Interlock 1 is active, the fan is shut down.
F2	FE	RW	EE 0	System/Interlocks	Fan Failure Interlock Trips Fan? When F2 is set to 0, Interlock 2 will not trip the fan. When set to 1 and Interlock 2 is active, the fan is shut down.
F3	FE	RW	EE 0	System/Interlocks	Fan Failure Interlock Trips Fan? When F3 is set to 0, Interlock 3 will not trip the fan. When set to 1 and Interlock 3 is active, the fan is shut down.

FF00 Attr.	Data Type	Access	Store & Default	SP for Windows Location	Description
IC	FE	R	0	System/Diagnostics	EEPROM Default Count increments whenever the EEPROM is restored to factory default settings (see FF00;DE Default Enable)
ID	FE	RW	EE SN	Network/Configuration	Unit Number used to set a unique network address for each controller connected to a multidrop
IS	E9	R	RAM N/A	System/Interlocks	Interlock Status displays the status of all of the interlocks bit 0=interlock 1 bit 1=interlock 2 bit 2=interlock 3
I1	FE	RW	EE 0	System/Interlocks	Interlock 1 Channel specifies the input to be used for interlock 1. Disabling this input disables the PID interlock 1 0=Disabled 1=UI1 2=UI2 3=UI3 4=UI4 5=UI5 6=OIA/B
I2	FE	RW	EE 0	System/Interlocks	Interlock 1 Channel specifies the input to be used for interlock 1. Disabling this input disables the PID interlock 1 0=Disabled 1=UI1 2=UI2 3=UI3 4=UI4 5=UI5 6=OIA/B
I3	FE	RW	EE 0	System/Interlocks	Fan Failure Interlock used as a Proof of Flow interlock. 0=Disabled 1=Fan Status.
OC	FE	RW	0	System/Diagnostics	Illegal Opcode Count increments upon firmware failure but can also be advanced during the removal of power
PD	FE	RW	EE 5	System/Power-up	Power On Delay time delay in seconds (0–255) that must elapse after the SBC-ASC(e) is reset before output control or alarm functions can begin: 0 = no delay, 1–255 = delay specified in seconds

FF00 Attr.	Data Type	Access	Store & Default	SP for Windows Location	Description
PS	FE	RW	EE 2	System/ Power-up	Power Up State schedule state the SBC-ASC(e) will operate in when it is initially powered or the state that it will operate in when power is restored after a power failure 0=unoccupied 1=warmup 2=occupied 3=night setback
RC	FE	R	0	System/ Diagnostics	Power-up Count increments each time power is applied to the controller. This counts power outages and noise related resets as well as resets initiated through FF00:RS
RE	FE	R	0	System/ Diagnostics	STATbus Reset Count increments each time a STATbus reset occurs. This attribute is used for diagnostic and troubleshooting purposes.
RI	FE	RW	EE 0	System/ Interlocks	Reset Fan Failure Interlock When Fan Failure Interlock is enabled to shut down the fan (FF00:F3=1), setting RI=1 allows the fan to restart.
RS	FE	RW	RAM 0	System/ Power-up	Reset to reset the SBC-ASC(e): 0 = disabled (default), 1 = reset the SBC-ASC(e)
SN	FE	R	EE factory set	System/ About	Serial Number displays the serial number of the SBC-ASC(e) controller

OUTSIDE TEMPERATURE CHANNEL,
FE09

FE09 Attr.	Data Type	Access	Store & Default	SP for Windows Location	Description
CV	FD	R RW if OI = 1	N/A	Temperature/ Outside	Outside Temperature shows the current value of OAT
OF	FD	RW	0.0	Temperature/ Outside	Outside Temperature Adjustment defines an offset used to adjust FE08; CV
OI	FE	RW	0	Temperature/ Outside	Override Outside Temperature when set to 1 this allows the outside temperature value (FE09; CV) to be altered manually
RE	FE	R	N/A	Temperature/ Outside	Channel Reliability indicates whether or not the OAT value can be trusted

SUPPLY TEMPERATURE CHANNEL,
FE08

FE08 Attr.	Data Type	Access	Store & Default	SP for Windows Location	Description
CV	FD	R RW if OI = 1	N/A	Temperature/ Supply	Supply Temperature shows the current value of source/duct temperature
DD	FD	RW	2.5	Temperature/ Supply	Auto Mode Deadband defines the temperature difference by which the supply air must either exceed FE00; HC to switch to heating mode, or fall below FE00; CC to engage cooling mode
OF	FD	RQ	0.0	Temperature/ Supply	Supply Temperature Adjustment defines an offset used to adjust FE08; CV
OI	RE	RW	0	Temperature/ Supply	Override Supply Temperature when set to 1 this allows the supply temperature value to be altered manually
RE	FE	R	N/A	Temperature/ Supply	Channel Reliability indicates whether or not the supply /duct temperature value can be trusted
SM	FE	R	N/A	Temperature/ Supply	Supply Mode indicates the current supply mode (cooling or heating)

UNIVERSAL INPUT CHANNEL, FE01- FE05

FE01 - FE05 Attr.	Data Type	Access	Store & Default	SP for Windows Location	Description
CV	FD	RW	RAM NA	I/O Setup/ Input (UI1)	Current Value shows the current value
DT	FE	RW	EE 253	I/O Setup/ Input (UI1)	Data Type for Input specifies the PUP data type for the input
HL	FD	RW	EE 0.0	I/O Setup/ Input (UI1)	High Alarm Limit if alarms are enabled and the current value rises above this value, a high limit alarm will be generated
HS	FD	RW	EE 0.0	I/O Setup/ Input (UI1)	Alarm Limit Hysteresis determines when the SBC-ASC(e) returns from a high or low limit alarm
IF	FE	RW	EE 0.0	I/O Setup/ Input (UI1)	Input Filter Delay specifies the amount of time in tenths of seconds during which an input configured as digital input must remain stable for the value to be considered reliable
IP	FE	RW	EE 0	I/O Setup/ Input (UI1)	Input Polarity specifies the input polarity when the input is configured as a digital input
LL	FD	RW	EE 0.0	I/O Setup/ Input (UI1)	Low Alarm Limit specifies the maximum engineering unit for the input corresponding to the highest value measured at the input connection
MN	FD	RW	EE 0.0	I/O Setup/ Input (UI1)	Minimum Scaled Value specifies the minimum engineering unit for the input corresponding to the lowest value measured at the input connection
MX	FD	RW	EE 0.0	I/O Setup/ Input (UI1)	Maximum Scaled Value specifies the maximum engineering unit for the input corresponding to the highest value measured at the input connection
OI	FE	RW	EE 0	I/O Setup/ Input (UI1)	Override Input allows a host or operator to directly set the value of the source/duct temperature

FE01 - FE05 Attr.	Data Type	Access	Store & Default	SP for Windows Location	Description
RE	FE	R	RAM NA	I/O Setup/ Input (UI1)	Data Reliability an analog input value is considered unreliable if it is out of range for the selected sensor type
ST	FE	RW	EE 7	I/O Setup/ Input (UI1)	Sensor Type selects one of the following input types: 0= digital 2= full scale, linear -5V dc or 0-20mA scaled from MN to MX 3= 4-20mA liner scaled from MN to MX 7= -22.0 to 122.0°F thermistor 1,4,5, and 6 unused
SU	FD	RW	EE 0.0	I/O Setup/ Input (UI1)	Amount of Setup/ Setback Alarm Limit specifies the amount added to FE04;HL or subtracted from FE04;LL during unoccupied periods
AE	FE	RW	EE 0	I/O Setup/ Input (UI1)	Alarm Enable specifies the type of alarm checking to be done on the FE04;CV value 0=disabled 1= contact (0→1) 2=contact (1→0) 3=change of state (1↔0) 4=low limit alarm 5=high limit alarm 6=low and high limit
AS	FE	R	RAM 0	I/O Setup/ Input (UI1)	Alarm Status shows the current alarm condition 0=normal 1=contact (0→1) 2=contact (1→0) 3=change of state 4=unused 5=low limit alarm 6=high limit alarm

ZONE TEMPERATURE CHANNEL, FE00

FE00 Attr.	Data Type	Access	Store & Default	SP for Windows Location	Description
ZT	FD	RW (W if FE00; OI = 1)	RAM NA	Temperature/ Thermostat	Zone Temperature shows the current temperature value measured by the thermostat as adjusted by FE00; OF
AE	FE	RW	EE 0	Temperature/ Alarms	Enable Alarming specifies the type of alarm checking to be done on the CV value 0=disabled 4=low limit alarm 5=high limit alarm 6=low and high limit 1-3 and 7-12 are unused
AS	FE	R	RAM 0	Temperature/ Alarms	Alarm Status shows the current alarm condition 0=normal 5=low limit 6=high limit 1-4 and 7-12 are unused
BM	FE	RW	0	Temperature/ Sensor Bus	Bus Mode should be set to Master (FE00; BM =0) unless multiple controllers are wired onto a SSB. Any additional controllers on the SSB must be configured as Slaves (FE00; BM =1).
BT	FE	RW	EE 1 cooling only	Temperature/ Thermostat	Control Mode this attribute specifies the type of VAV terminal box being used 0 = none 1 = cooling only 2 = heating only 3 = supply dependant
CC	FD	R	RAM NA	Temperature/ Cooling Setpoints	Current Setpoint this attribute shows the current cooling control setpoint
CH	FD	R	RAM	Temperature/ Heating Setpoints	Current Setpoint this attribute shows the current heating control setpoint
CV	FD	RW	RAM NA	Temperature/ Alarms	Current Value shows the current value of the input
DF	RE	RW	EE 3 ###	Temperature/ Sensor Bus	Display Format defines the format used to display the current temperature on the digital thermostat. The display of the tenths digit and the Fahrenheit/Celsius character are options. Also, the display may be eliminated.

FE00 Attr.	Data Type	Access	Store & Default	SP for Windows Location	Description
DL	FD	R	NA	Temperature/ Thermostat	Demand Load indicates the heating/cooling demand in terms of the temperature separation from setpoints
DM	FE	R	NA	Temperature/ Thermostat	Zone Demand indicates the demand for the zone 0 = ##d 1 = ##.#d 2 = ##.dF 3 = ##.#dF 4 = None
DS	FE	RW	EE 0 degrees F	Temperature/ Sensor Bus	Display Mode specifies whether English or Metric units are to be used for the digital thermostat display
DV	FE	RW	0	Temperature/ Sensor Bus	Display Value , when FE00; DV =0 each digital thermostat displays the identical temperature value (average) (FE00; ZT). When FE00; DV =1 each thermostat displays its own temperature
ED	FE	RW	EE 60 minutes	Temperature/ Override	Extended Occupancy Duration this attribute specifies the amount of time, in minutes, to extend occupancy
ER	FE	R	RAM NA	Temperature/ Override	Extended Occupancy Remaining this attribute shows the amount of time remaining in extended occupancy
G0	FE	R	RAM	Temperature/ Sensor Bus	GID Device 0 is the global identification for the SSB device
G1	FE	R	RAM	Temperature/ Sensor Bus	GID Device 1 is the global identification for the SSB device
G2	FE	R	RAM	Temperature/ Sensor Bus	GID Device 2 is the global identification for the SSB device
G3	FE	R	RAM	Temperature/ Sensor Bus	GID Device 3 is the global identification for the SSB device
HL	FD	RW	EE 0.0	Temperature/ Alarms	High Alarm Limit if alarms are enabled and the current value rises above this value, a high limit alarm will be generated
HS	FD	RW	EE 0.0	Temperature/ Alarms	Alarm Limit Hysteresis determines when the SBC-ASC(e) returns from a high or low limit alarm

FE00 Attr.	Data Type	Access	Store & Default	SP for Windows Location	Description
LL	FD	RW	EE 0.0	Temperature/Alarms	Low Alarm Limit if alarms are enabled and the current value drops below this value, a low limit alarm will be generated
NC	FD	RW	EE 5.0	Temperature/Cooling Setpoints	Night Setback this attribute specifies, in +/- degrees, the amount to be added to the cooling setpoint (FE00;SC) when the SBC-ASC(e) is in night setback mode
NH	FD	RW	EE 10.0°F	Temperature/Heating Setpoints	Night Setback specifies, in +/- degrees, the amount to be added to the heating setpoint (FE00;SH) when the SBC-ASC(e) is in night setback mode
OF	FD	RW	EE 0	Temperature/Thermostat	Temperature Correction this defines the correction that is being applied to temperature readings
OI	FE	RW	EE 0	Temperature/Thermostat	Override Temperature Value when set to 1, it allows you to write to FE00;ZT directly
PB	FE	RW	EE 2200	Temperature/Sensor Bus	Balancer P.I.N. this personal identification number controls access to the Balance Menu
PG	FE	RW	EE	Temperature/Sensor Bus	Primary GID specifies the GID of the Primary SBC-STAT in Primary GID mode (RM=8). If this SBC-STAT is not available then the Average temperature mode (RM=0) is used.
PI	FE	RW	EE 3300	Temperature/Sensor Bus	Installer P.I.N. this Personal Identification Number controls access to all menus.
PS	FE	RW	EE 1100	Temperature/Sensor Bus	Service P.I.N. this personal identification number controls access to the Service Menu
PU	FE	RW	EE 0	Temperature/Sensor Bus	User P.I.N. this personal identification number controls access to the User Menu

FE00 Attr.	Data Type	Access	Store & Default	SP for Windows Location	Description
RD	FD	RW	15.0	Temperature/Thermostat	Reversing Delay specifies the delay, in minutes, imposed before heating can begin after a period of cooling, or cooling can begin after a period of heating
RM	FE	RW	EE 0 Average	Temperature/Sensor Bus	Reading Mode specifies the technique used to determine Zone Temperature when multiple SBC-STATs are used. 0 = Average 1 = Highest 2 = Lowest 3 = Hi/Lo VST mode 4-7 = Device 0-Device 3 8 = Primary GID
SC	FD	RW	EE 72.0	Temperature/Cooling Setpoints	Cooling Setpoint shows the zone temperature setpoint desired to begin cooling control
SD	FE	RW	EE 0	Temperature/Setpoint Adjust	Calculated Setpoint Display Users can select a method of setpoint adjustment that is displayed when users adjust the setpoint on an SBC-STAT3.
SE	FE	RW	EE 1 enables	Temperature/Override	User Override this attribute enables or disables your ability to enter extended occupancy override 0 = disabled 1 = enabled
SH	FD	RW	EE 68.0°F	Temperature/Heating Setpoints	Heating Setpoint this attribute shows the zone temperature setpoint desired to begin heating control
SU	FE	RW	EE 0.0	Temperature/Alarms	Amount to Setup/Setback Alarm Limit specifies the amount added to HL or subtracted from LL during unoccupied periods
SW	FD	RW	EE 72.0°F	Temperature/Heating Setpoints	Warm-up Setpoint shows the zone temperature setpoint desired for beginning warm-up heating control
T0	FD	R	RAM	Temperature/Sensor Bus	Reading Device 0 is the raw reading for Device 1 on an SSB
T1	FD	R	RAM	Temperature/Sensor Bus	Reading Device 1 is the raw reading for Device 2 on an SSB
T2	FD	R	RAM	Temperature/Sensor Bus	Reading Device 2 is the raw reading for Device 3 on an SSB

FE00 Attr.	Data Type	Access	Store & Default	SP for Windows Location	Description
T3	FD	R	RAM	Temperature/ Sensor Bus	Reading Device 3 is the raw reading for Device 4 on an SSB
TM	FD	RW	EE 0.5°F	Temperature/ Setpoint Adjust	User Adjust Increment this attribute specifies the magnitude of incremental changes to the User Setpoint Offset (FE00;TS)
TP	FF	RW	RAM 0	Temperature/ Setpoint Adjust	User Adjust Position the User Setpoint Offset (FE00;TS) can be raised or lowered in integral steps; the FE00;TP attribute tracks the current step
TR	FE	RW	RAM 0	Temperature/ Setpoint Adjust	User Adjust Remaining displays the time remaining before the User Setpoint Offset (FE00;TS) setting is reset
TS	FD	R	RAM 0	Temperature/ Setpoint Adjust	User Setpoint Offset this attribute defines an offset to be applied to PID setpoints
TT	FE	RW	EE 120 minutes	Temperature/ Setpoint Adjust	User Setpoint Offset the User Setpoint Offset (FE00;TS) is a temporary setting; the FE00;TT attribute defines in minutes the duration for which the setting applies
UC	FD	RW	EE 5.0	Temperature/ Cooling Setpoints	Unoccupied Setback this attribute specifies, +/- degrees, the amount to be added to the cooling setpoint (FE00;SC) when the SBC-ASC(e) schedule is in unoccupied mode
UH	FD	RW	EE 10.0°F	Temperature/ Heating Setpoints	Unoccupied Setback specifies, in +/- degrees, the amount to be added to the heating setpoint (FE00;SH) when the SBC-ASC(e) is in UNOCCUPIED mode
ZS	FD	RW	RAM 70.0	Temperature/ Setpoint Adjust	Zone Midpoint displays the midpoint between the current cooling and heating setpoints.
RH	FD	R	RAM	Aux/Relative Humidity	Relative Humidity displays the current sensed humidity from a connected SBC-RHT thermostat.
HD	FE	RW	EE 0	Aux/Relative Humidity	Display Relative Humidity Indicates if RH should be displayed on the LCD of a connected SBC-RHT.

FE00 Attr.	Data Type	Access	Store & Default	SP for Windows Location	Description
HC	FD	RW	EE 0.0	Aux/Relative Humidity	Relative Humidity Correction defines a correction offset for relative humidity.
HO	FE	RW	EE 0	Aux/Relative Humidity	Override Relative Humidity defines whether or not to override the current sensed relative humidity.

ANALOG OUTPUT CHANNEL, FDO1-FD04

FD01 - FD04 Attr.	Data Type	Access	Store & Default	SP for Windows Location	Description
CV	FC	RW	RAM 0.0	I/O Setup/ Output (AO1)	Current Output Value shows the current value of the analog output
DT	FE	RW	EE 252	I/O Setup/ Output (AO1)	Data Type for Output specifies the PUP data type for the analog output
HS	FA	RW	EE 100.0	I/O Setup/ Output (AO1)	Maximum Scaled Voltage specifies the actual analog output value for a FD01; CV value of FD01; MX
LS	FA	RW	EE 0.00	I/O Setup/ Output (AO1)	Minimum Scaled Voltage specifies the actual analog output value for a FD01; CV value of FDO1; MN
MN	FC	RW	EE 0.0	I/O Setup/ Output (AO1)	Minimum Scaled Value specifies the minimum scaled value for the analog output corresponding to the lowest value output
MX	FC	RW	EE 100.0	I/O Setup/ Output (AO1)	Maximum Scaled Value specifies the maximum scaled value for the analog output corresponding to the highest value output
AM	FE	RW	EE 0	I/O Setup/ Output (AO1)	Automatic/Manual Control selects the control mode for the analog output

PULSE CHANNEL, FC03

FC03 Attr.	Data Type	Access	Store & Default	SP for Windows Location	Description
CV	FE	R	RAM	Aux/ Pulse Channel	Current State reports the current status, 0 or 1, for the binary inputs
MD	FE	RW	EE 0	Aux/ Pulse Channel	Counter Mode select an option for the counter 0 = Disabled 1 = falling edges 2 = enabled to count on signal rising edges 3 = both edges
NP	FE	RW	RAM 0	Aux/ Pulse Channel	Pulse Count reports the count of detected edges. To clear or initialize the count, you can write to this attribute.
SF	F9	RW	EE 0.000	Aux/ Pulse Channel	Pulse Scale Factor the weighted value of each pulse count
SV	F9	R	RAM 0.0000	Aux/ Pulse Channel	Pulse Scaled Value the product of the current pulse count and the pulse scale factor

FAN STATUS CHANNEL, FC02

FC02 Attr.	Data Type	Access	Store & Default	SP for Windows Location	Description
PF	FE	R	N/A	Aux/Fan Status	Fan Status shows that status of the fan
IC	FE	RW	0 = None	Aux/Fan Status	Status Input selects the digital input where a non-zero value indicates flow 0 =None 1 = UI1 2 = UI2 3 = UI3 4 = UI4 5 = UI5 6 = OIA/B
PD	FE	RW	60	Aux/Fan Status	Delay shows the amount of time, in seconds, imposed before enabling a positive flow indication

OCCUPANCY DETECTOR CHANNEL, FC01

FC01 Attr.	Data Type	Access	Store & Default	SP for Windows Location	Description
MS	FE	R	RAM NA	Aux/ Occupa ncy Detector	Occupancy Status shows the status of the occupancy detector digital input
MT	FE	RW	EE 0	Aux/ Occupa ncy Detector	Extended Occupancy Duration defines, in minutes, the length of time to override the zone whenever occupancy is detected
IC	FE	RW	EE 0	Aux/ Occupa ncy Detector	Status Input selects an input to use 0 = None 1 = UI1 2 = UI2 3 = UI3 4 = UI4 5 = UI5 6 = OIA/B
MD	FE	RW	EE 30	Aux/ Occupa ncy Detector	Extended Occupancy Delay sets the amount of time, in seconds, during which the occupancy detector must remain on before it will override the zone
MR	FE	R	RAM NA	Aux/ Occupa ncy Detector	Extended Occupancy Remaining displays the time remaining for occupancy detector override

DIGITAL OUTPUT CHANNEL (K1-K5), FB01-FB05

FB01 - FB05 Attr.	Data Type	Access	Store & Default	SP for Windows Location	Description
CV	FE	RW	RAM NA	I/O setup/ Relay Outputs	Current Output Value shows the current value for the analog output
OI	FE	RW	EE 0 Off	I/O setup/ Relay Outputs	Override overrides the digital output. On (OI = 1) constantly energizes the output; Off (OI = 0) disables the output; Auto (OI = 2) allows for automatic control; Manual (OI = 3) allows the CV to be directly written. The factory default setting is OI = 1 (Off) to allow full configuration before equipment operation. Each digital output must be manually enabled.
OP	FE	RW	EE 0	I/O setup/ Relay Outputs	Output Polarity allows you to change the polarity of the output
RH	FC	RW	*	I/O setup/ Relay Outputs	Runtime Hours shows the total amount of time, in hours, during which the output has been energized
RL	FC	RW	EE 0.0	I/O setup/ Relay Outputs	Runtime Limit specifies a run time limit in hours for the output

FAN DIGITAL OUTPUT CHANNEL (K1), FB01

FB01 Attr.	Data Type	Access	Store & Default	SP for Windows Location	Description
FD	FE	RW	30	Equipment/ Fan	Shutoff Delay shows the amount of time, in seconds, the fan output will stay energized once the zone temperature reaches the deadband
FN	FE	RW	0	Equipment/ Fan	Night Setback Mode defines the mode of the fan during the night setback schedule state. When FN = 0, the fan runs for the entire period. When FN = 1, the fan shuts off when the zone temperature is within the deadband.

FB01 Attr.	Data Type	Access	Store & Default	SP for Windows Location	Description
FO	FE	RW	EE 0	Equipment/ Fan	Occupied Mode defines the mode of the fan during the occupied schedule state. When FO = 1, the fan runs for the entire period. When FO = 0, the fan shuts off when the zone temperature is within the deadband.
FR	FD	RW	0.5	Equipment/ Fan	Minimum Run Time shows the minimum amount of time, in minutes, the fan output will stay energized
FS	FD	RW	1.0	Equipment/ Fan	Minimum Off Time shows the minimum amount of time, in minutes, the fan output will stay de-energized
FU	FE	RW	0	Equipment/ Fan	Unoccupied Mode defines the mode of the fan during the unoccupied schedule state. When FU = 0, the fan runs for the entire period. When FU = 1, the fan shuts off when the zone temperature is within the deadband.
FX	FD	RW	0.0	Equipment/ Fan	Staging Delay indicates the maximum amount of time, in minutes, that the fan will operate before energizing the first stage of heating or cooling
DB	FD	RW	EE 0.0	Equipment/ Fan	Fan Automode Deaband used exclusively in conjunction with fan modes (FO , FU , FN) that are configured for Auto modes. When the device is in a schedule state where the fan operates in auto mode, the current zone temperature must exceed setpoint plus or minus the deadband temperature value in order for the fan to activate, followed by stages of heating or cooling. This property is useful for preventing the fan from turning on in situations where the zone temperature could possibly drift closely near mode changes.

FB01 Attr.	Data Type	Access	Store & Default	SP for Windows Location	Description
MT	FE	R	RAM *	Equipment/ Fan	Min Run/Off Timer reflects the amount of time remaining (in seconds) if the output is currently respecting minimum-on or minimum-off time.

COOLING STAGE 1, FB02

FB02 Attr.	Data Type	Access	Store & Default	SP for Windows Location	Description
MR	FD	RW	3.0	Equipment/ Cool 1	Minimum Run Time shows the minimum amount of time, in minutes, the stage will stay energized when cooling.
MS	FD	RW	7.0	Equipment/ Cool 1	Minimum Off Time shows the minimum amount of time, in minutes, the stage will remain de-energized when cooling.
MX	FD	RW	20.0	Equipment/ Cool 1	Staging Delay indicates the maximum amount of time, in minutes, that the heating stage will operate before energizing the next stage of cooling
TL	FD	RW	45.0	Equipment/ Cool 1	Cooling DAT Low Temp Lockout cooling stages will be engaged only if there is a reliable source/duct temperature (DAT) below this setting.
TO	FD	RW	0.0	Equipment/ Cool 1	Temp Offset indicates the temperature offset from setpoint required before engaging the stage for cooling
CL	FD	RW	55.0	Equipment/ Cool 1	Cooling OAT Lockout cooling stages will not be engaged if a Reliable (FE09;RE=0) Outside Air Temperature (FE09;CV) is available that is above the temperature specified by this attribute. Stages will not be de-energized should the OAT rise above this temperature during an active cycle.
MT	FE	R	RAM *	Equipment/ Cool 1	Min Run/Off Timer reflects the amount of time remaining (in seconds) if the output is currently respecting minimum-on or minimum-off time.

COOLING STAGE 2, FB03

FB03 Attr.	Data Type	Access	Store & Default	SP for Windows Location	Description
MR	FD	RW	3.0	Equipment/ Cool 2	Min Run Time shows the minimum amount of time, in minutes, the stage will stay energized when cooling.
MS	FD	RW	7.0	Equipment/ Cool 2	Minimum Off Time shows the minimum amount of time, in minutes, the stage will remain de-energized when cooling.
TO	FD	RW	2.0	Equipment/ Cool 2	Temp Offset indicates the temperature offset from setpoint required before engaging the stage for cooling. Note that the stage may also engage if the Staging Delay for the prior stage expires.
MT	FE	R	RAM *	Equipment/ Cool 2	Min Run/Off Timer reflects the amount of time remaining (in seconds) if the output is currently respecting minimum-on or minimum-off time.

HEATING STAGE 1, FB04

FB04 Attr.	Data Type	Access	Store & Default	SP for Windows Location	Description
HL	FD	RW	80.0	Equipm ent/Heat 1	OAT Lockout heating stages will not be engaged if a Reliable (FE09;RE=0) Outside Air Temperature (FE09;CV) is available that is above the temperature specified by this attribute. Stages will not be de-energized should the OAT rise above this temperature during an active cycle.
MR	FD	RW	3.0	Equipm ent/Heat 1	Min Run Time shows the minimum amount of time, in minutes, the stage will stay energized when heating.
MS	FD	RW	7.0	Equipm ent/Heat 1	Min Off Time shows the minimum amount of time, in minutes, the stage will remain de-energized when heating.
MX	FD	RW	20.0	Equipm ent/Heat 1	Staging Delay indicates the maximum amount of time, in minutes, that the heating stage will operate before energizing the next stage of heating

FB04 Attr.	Data Type	Access	Store & Default	SP for Windows Location	Description
TH	FD	RW	105.0	Equipm ent/Heat 1	DAT High Temp Lockout heating stages will be engaged only if there is a reliable source/duct temperature (DAT) below this setting.
TO	FD	RW	0.0	Equipm ent/Heat 1	Temp Offset indicates the temperature offset from setpoint required before engaging the stage for Heating. Note that the stage may also engage if the Staging Delay for the prior stage expires.
MT	FE	R	RAM *	Equipm ent/Heat 1	Min Run/Off Timer reflects the amount of time remaining (in seconds) if the output is currently respecting minimum-on or minimum-off time.

HEATING STAGE 2, FB05

FB05 Attr.	Data Type	Access	Store & Default	SP for Windows Location	Description
MR	FD	RW	3.0	Equipm ent/ Heat 2	Min Run Time shows the minimum amount of time, in minutes, the stage will stay energized when heating.
MS	FD	RW	7.0	Equipm ent/ Heat 2	Min Off Time shows the minimum amount of time, in minutes, the stage will remain de-energized when heating.
TO	FD	RW	2.0	Equipm ent/ Heat 2	Temp Offset indicates the temperature offset from setpoint required before engaging the stage for Heating. Note that the stage may also engage if the Staging Delay for the prior stage expires.
MT	FE	R	RAM *	Equipm ent/ Cool 2	Min Run/Off Timer reflects the amount of time remaining (in seconds) if the output is currently respecting minimum-on or minimum-off time.

PID CONTROL CHANNEL, FA11-FA14

FA11 - FA14 Attr.	Data Type	Access	Store & Value	SP for Windows Location	Description
AO	FC	RW	RAM NA	Aux/PID Control	Analog Output Value shows the scaled output value used by the analog output
CE	FE	RW	EE 0	Aux/PID Control	Enable Control Loop enables the PID loop
CS	FD	R	RAM NA	Aux/PID Control	Calculated Control Setpoint shows the actual loop control setpoint
DB	FC	RW	EE 0	Aux/PID Control	Deadband specifies the input variable range in which no control action occurs
IC	FE	RW	EE 0	Aux/PID Control	Loop Measured Variable specifies the input to be used for the measured variable for the control loop 0= disabled 1=Zone Temp 2=Supply Temp 4=UI1 5=UI2 6 =UI3 7 =UI4 8=UI5 9=Zone Heating 10=Zone Cooling 11=Outside Air Temperature 13=Relative Humidity
ID	FE	RW	EE 0	Aux/PID Control	Interlock Enable/Disable enables/disables the interlocks for the PID. When an interlock input is = 1 (enabled), the PID control output is set to the value of the interlock failure position.
IN	FC	R	RAM 0	Aux/PID Control	Measured Variable's Value displays the value of the input selected in FA04; IC
MR	FC	RW	EE 0	Aux/PID Control	Maximum Amount to Reset Setpoint specifies the maximum amount by which to reset the loop setpoint (SP) when reset is being used
PB	FC	RW	EE 0	Aux/PID Control	Proportional Band specifies the input variable range over which the output value is proportional to the error value

FA11 - FA14 Attr.	Data Type	Access	Store & Value	SP for Windows Location	Description
PO	FC	R	RAM NA	Aux/PID Control	Percent Output Value shows the output value in hundredths of a percent
P1	FC	RW	EE 0	Aux/PID Control	Interlock 1 Position specifies the PID output value when Interlock 1 is active and enabled.
P2	FC	RW	EE 0	Aux/PID Control	Interlock 2 Position specifies the PID output value when Interlock 2 is active and enabled.
P3	FC	RW	EE 0	Aux/PID Control	No Flow Position specifies the PID output value when the current value of Fan Status is equal to 0 (No Flow).
RC	FC	R	RAM NA	Aux/PID Control	Reset Variable's Value displays the value of the input selected in RV
RL	FC	RW	EE 0	Aux/PID Control	Limit for Maximum Reset specifies the value at which maximum reset is used
RP	FE	RW	EE 0	Aux/PID Control	Reset Period specifies the reset period (in seconds) over which the error history is accumulated
RS	FC	RW	EE 0	Aux/PID Control	Setpoint at Which Reset Action Begins specifies the value at which the reset action begins
RT	FC	RW	EE 0	Aux/PID Control	Derivative Rate specifies a percentage of change in error that is to be used in calculating FA04; PO
RV	FE	RW	EE 0	Aux/PID Control	Reset Variable specifies the input to be used for calculating the reset 0=disabled 1=Zone Temp 2=Supply Temp 4=UI1 5=UI2 6=UI3 7=UI4 8=UI5 11=Outside Air Temperature 13=Relative Humidity
SG	FE	RW	EE 0	Aux/PID Control	Control Action specifies the control action for the control loop 0 = normal 1 = reverse
SP	FD	RW	EE 0	Aux/PID Control	Loop Setpoint specifies the desired loop setpoint

FA11 - FA14 Attr.	Data Type	Access	Store & Value	SP for Windows Location	Description
SU	FC	RW	EE 0	Aux/PID Control	Unoccupied Setup/ Setback specifies the amount to add (if SG = 0) or subtract (if SG = 1) from the setpoint during an unoccupied period

ECONOMIZER CHANNEL, FA01

FA01 Attr.	Data Type	Access	Store & Default	SP for Windows Location	Description
EE	FE	RW	EE 0	Auxiliary/ Economizer	Economizer Enable specifies the PID channel or DO to be used for economizer control. 0=Off 1=PID 1 2=PID 2 3=PID 3 4=PID 4 5=DO 3 6=DO 5
OH	FD	RW	EE 60.0	Auxiliary/ Economizer	OAT High Limit If the OAT is above the high limit and the economizer is enabled, the PID is set to the Minimum Position (as specified in FA01; EM).
OL	FC	RW	EE 45.0	Auxiliary/ Economizer	OAT Low Limit If the OAT is below the low limit and the economizer is enabled, the PID is set to the Minimum Position (as specified in FA01; EM).
EM	FC	RW	EE 10.0	Auxiliary/ Economizer	Minimum Position specifies the PID minimum position in percent for the economizer damper.
ED	FC	RW	EE 1.0	Auxiliary/ Economizer	Economizer Staging Delay Specifies how many minutes the controller waits before using additional cooling stages after the economizer damper reaches 100%.
CM	FC	RW	RAM N/A	Auxiliary/ Economizer	Calculated Minimum Position displays the actual minimum position of the economizer damper
MV	FC	RW	EE 0	Auxiliary/ Economizer	Reset variable allows you to specify an input sensor that is to be used to reset the minimum position of the economizer (FA01; EM).
MP	FC	RW	EE 0	Auxiliary/ Economizer	Reset Setpoint Specifies the value at which the reset action begins. When the value of the reset variable exceeds MP , reset action will be used in determining the economizer minimum position.

FA01 Attr.	Data Type	Access	Store & Default	SP for Windows Location	Description
MR	FC	RW	EE 0	Auxiliary/ Economizer	Maximum Reset specifies the maximum amount by which to reset the minimum position setpoint (EM) when reset is being used.
ML	FC	RW	EE 0	Auxiliary/ Economizer	Reset Limit When the value of the reset variable is equal to ML , the maximum reset (MR) is used in determining the calculated minimum position.

SCHEDULE 1 THROUGH SCHEDULE 6 CHANNEL, F901-F906

F901-F906 Attr.	Data Type	Access	Store & Default	SP for Windows Location	Description
CV	FE	R	RAM NA	Schedul es/1-6	Current Schedule Value indicates the current state of the schedule: 0 = unoccupied mode, 1 = warm-up, 2 = occupied mode, 3 = night setback
NS	E6	RW	EE 19:00	Schedul es/1-6	Night Setback start time in short military format when night setback should begin
OC	E6	RW	EE 08:00	Schedul es/1-6	Occupied Time start time in short military format when occupied mode should begin
UN	E6	RW	EE 17:00	Schedul es/1-6	Unoccupied Time start time in short military format when unoccupied mode should begin
WO	E6	RW	EE 07:00	Schedul es/1-6	Warm-up Time start time in short military format when warm-up mode should begin
AD	E9	RW	EE M T W T F	Schedul es/1-6	Active Days Day-of-week map specifying which of eight possible days of the week (seven days plus holiday) that the schedule is active 0 = Monday 1 = Tuesday 2 = Wednesday 3 = Thursday 4 = Friday 5 = Saturday 6 = Sunday 7 = Holiday
AO	FE	RW	EE 0	Schedul es/1-6	All-Day Override this attribute is used to override the schedule in WO, OC, UN, and NS for active days 0= none 1 = unoccupied 2 = warm-up 3 = occupied 4 = night setback

MAIN SCHEDULE CHANNEL, F900

F900 Attr.	Data Type	Access	Store & Default	SP for Windows Location	Description
CV	FE	R	RAM NA	Schedules /Summary	Current Value for Schedule read only attribute that displays the present schedule operating state of the SBC-ASC(e) as determined by priority checking 0 = unoccupied 1 = warm-up 2 = occupied 3 = night setback
DA	FE	RW	RAM NA	Schedules /Clock/ Calendar	Day of the Week specifies the current day of the week as a number from 0-7; must be set by a host controller for proper operation (default invalid): bit #0 = Monday bit #1 = Tuesday bit #2 = Wednesday bit #3 = Thursday bit #4 = Friday bit #5 = Saturday bit #6 = Sunday
DH	FE	RW	RAM	Schedules /Clock/ Calendar	Holiday toggles the holiday status for the current day
DT	E4	RW	RAM NA	Schedules /Clock/ Calendar	Current Date specifies the current date in MM/DD/YY format.
H0-H9	E4	RW	N/A	Schedules /Clock/ Calendar	Programmed Holiday specified date to be considered a holiday. Set this attribute to 0/0/YY to ignore
HE	FE	RW	EE 0	Schedules /Summary	Host Schedule Override Enable specifies whether the SBC-ASC(e) will operate from its local schedules or from a host on the network: 0 = CV is set by schedules F901-F906, 1 = CV is set by HO (ZE must = 0)
HO	FE	RW	RAM 0	Schedules /Summary	Host Schedule Override specifies the desired schedule override state of the SBC-ASC(e) when HE = 1: 0 = unoccupied 1 = warm-up 2 = occupied 3 = night setback

F900 Attr.	Data Type	Access	Store & Default	SP for Windows Location	Description
IS	FE	RW	EE 3	Schedules /Summary	Inactive Schedule specifies which of the four possible schedule modes is used by the SBC-ASC(e) schedules during inactive schedule periods (when current day of the week is not an active day) 0 = unoccupied 1 = warm-up 2 = occupied 3 = night setback
TM	E6	RW	RAM NA	Schedules /Clock/ Calendar	Time specifies the current system time (HH:MM) in military format from 00:00 to 23:59 (default invalid)
ZE	FE	RW	EE 0	Schedules /Summary	Zone Schedule Enable used to set the current schedule mode for the entire zone from the network broadcast of a controller capable of broadcasting zone schedule information to multiple SBC-ASC(e)s in the zone
AS	E9	R	RAM NA	Schedules /Summary	Active Schedule Bitmap displays the currently active schedules in bitmap form bit #0=F901 bit #1=F902 bit #2=F903 bit #3=F904 bit #4=F905 bit #5=F906 Bits #6 and #7 are unused
C1-C6	FE	R	RAM NA	Schedules /Summary	Current Value of Schedules 1-6 reflects the current value of F901-F906;CV 0 = unoccupied 1 = warm-up 2 = occupied 3 = night setback

NETWORK BROADCAST CHANNEL, F005

F005	Data Type	Access	Store & Default	SP for Windows Location	Description
CV	FE	R	RAM 0	Network/ Schedule Broadcast	Current Value shows the current value of the network broadcast schedule values received by the SBC-ASC(e)
RB	FE	RW	EE 0	Network/ Schedule Broadcast	Receive Broadcast enables the SBC-ASC(e) to receive network broadcasts and sets the F900; CV value based on the received value

OUTSIDE AIR TEMPERATURE (OAT) CHANNEL, F000

F000	Data Type	Access	Store & Default	SP for Windows Location	Description
CV	FE	R	RAM 0	Network/ OAT Broadcast	Current Value shows the current value of the network broadcast schedule values received by the SBC-ASC(e)
RB	FE	RW	EE 0	Network/ OAT Broadcast	Receive Broadcast enables the SBC-ASC(e) to receive network broadcasts and sets the F900; CV value based on the received value
BE	FE	RW	0	Network/ OAT Broadcast	Broadcast Enable enables active broadcast of a reliable FE09; CV Outside Air Temperature (OAT)

APPENDIX B: HEAT PUMP PUP CHANNELS AND ATTRIBUTES

The following tables contain a list of Public Unitary Protocol (PUP) attribute and channel assignments for the Heat Pump application. Each attribute is given with its PUP channel assignment, PUP data type, access code, where it is stored, its SoloPro for Windows location and a brief description.

SYSTEM CHANNEL, FF00

FF00 Attr.	Data Type	Access	Store & Default	SP for Windows Location	Description
SR	FE	R	Flash	System/About	Flash Release Code uniquely defines each flash firmware image
TF	FE	RW	EE 0	System/Interlocks	Time in Fire number of minutes the SBC-ASC remains in fire mode upon receipt of a "Change Operation Mode" broadcast. If TF = 0, the SBC-ASC will remain in fire mode until the controller is reset. If TF = 255, then the SBC-ASC will not accept "Change of Mode" broadcasts.
TP	FE	RW	EE 0 Irrresp. Peers	Network/Configuration	Token Passing Type defines the mode for token passing. When a controller is an Irresponsible Peer it will always return a token to the device that passed it, after performing any pending transactions. In Full Administrator mode, the token is passed to each unit listed in the Peer List (FF00;U1 through FF00;U4). 0 = irresponsible peer 1 = full administrator
U1-U4	FE	RW	EE 65535	Network/Configuration	Peer Unit Number defines the Unit ID of a peer. In Full Administrator mode the token is passed to each unit in the Peer List.
UP	FE	R	0	System/Diagnostics	Flash Update Count increments each time a new flash firmware image is accepted by the controller.
VE	FA	R	Flash	System/About	Version Number contains the factory-set firmware version
WC	FE	R	0	System/Diagnostics	Watchdog Count increments upon firmware failure but can also be advanced during the removal of power

FF00 Attr.	Data Type	Access	Store & Default	SP for Windows Location	Description
ZN	FE	RW	EE 0	Network/Configuration	Zone Number from 0 to 65,535 used to group controllers so that they can be controlled simultaneously
ZP	FE	RW	0	System/Diagnostics	MMT Pulse Count advances when MMT takes action to maintain the operation of the actuator
BU	FE	RW	RAM 0	System/Power-up	Back Up RAM Values copies specific attribute values from RAM to EEPROM when set to 1: 0 = normal operation, 1 = back up RAM to EEPROM
CC	FE	RW	0	System/Diagnostics	Clock Fail Count increments upon hardware failure but can also be advanced during the removal of power
CM	FE	R	Flash 255	System/About	Controller Manufacturer contains the factory-set manufacturer number for the unitary controller
CP	FE	RW	EE 0	Network/Configuration	Communication Speed specifies the communication speed (baud rate) at which devices on this network will communicate 0=9600 1=4800 2=2400 3=1200 4=reserved 5=reserved 6=38.4K 7=19.2K 8=115.2K 9=57.6K
CT	FE	R	Flash 101	System/About	Controller Type factory-set controller type identifies the type of unitary controller
DE	FE	RW	RAM	System/Power-up	Default Enable this attribute is used to restore configuration settings to factory defaults

FF00 Attr.	Data Type	Access	Store & Default	SP for Windows Location	Description
EM	FE	RW	EE 0	System/About	English/Metric specifies which units of measurement to use in returning temperature and airflow values: 0 = English Units; 1 = Metric Units
ER	FE	RW	EE 0 Disabl ed	Network/ Configuration	Token Recovery enables Token Recovery. In a token passing environment there should always be network activity, but if a token is lost the network will fall silent. If Token Recovery is enabled, and a token is lost, Full Administrator will detect the condition and initiate a new token. 0 = disabled 1 = enabled
FT	FE	R	Flash 5	System/ About	Firmware Type defines the class of firmware operating system used in this controller
F1	FE	RW	EE 0	System/ Interlocks	Fan Failure Interlock Trips Fan? When F1 is set to 0, Interlock 1 will not trip the fan. When set to 1 and Interlock 1 is active, the fan is shut down.
F2	FE	RW	EE 0	System/ Interlocks	Fan Failure Interlock Trips Fan? When F2 is set to 0, Interlock 2 will not trip the fan. When set to 1 and Interlock 2 is active, the fan is shut down.
F3	FE	RW	EE 0	System/ Interlocks	Fan Failure Interlock Trips Fan? When F3 is set to 0, Interlock 3 will not trip the fan. When set to 1 and Interlock 3 is active, the fan is shut down.
IC	FE	R	0	System/ Diagnostics	EEPROM Default Count increments whenever the EEPROM is restored to factory default settings (see FF00;DE Default Enable)
ID	FE	RW	EE SN	Network/ Configuration	Unit Number used to set a unique network address for each controller connected to a multidrop
IS	E9	R	RAM N/A	System/ Interlocks	Interlock Status displays the status of all of the interlocks bit 0=interlock 1 bit 1=interlock 2 bit 2=interlock 3

FF00 Attr.	Data Type	Access	Store & Default	SP for Windows Location	Description
I1	FE	RW	EE 0	System/ Interlocks	Interlock 1 Channel specifies the input to be used for interlock 1. Disabling this input disables the PID interlock 1 0=Disabled 1=UI1 2=UI2 3=UI3 4=UI4 5=UI5 6=OIA/B
I2	FE	RW	EE 0	System/ Interlocks	Interlock 1 Channel specifies the input to be used for interlock 1. Disabling this input disables the PID interlock 1 0=Disabled 1=UI1 2=UI2 3=UI3 4=UI4 5=UI5 6=OIA/B
I3	FE	RW	EE 0	System/ Interlocks	Fan Failure Interlock used as a Proof of Flow interlock. 0=Disabled 1=Fan Status.
OC	FE	RW	0	System/ Diagnostics	Illegal Opcode Count increments upon firmware failure but can also be advanced during the removal of power
PD	FE	RW	EE 5	System/ Power-up	Power On Delay time delay in seconds (0-255) that must elapse after the SBC-ASC(e) is reset before output control or alarm functions can begin: 0 = no delay, 1-255 = delay specified in seconds
PS	FE	RW	EE 2	System/ Power-up	Power Up State schedule state the SBC-ASC(e) will operate in when it is initially powered or the state that it will operate in when power is restored after a power failure 0=unoccupied 1=warmup 2=occupied 3=night setback
RC	FE	R	0	System/ Diagnostics	Power-up Count increments each time power is applied to the controller. This counts power outages and noise related resets as well as resets initiated through FF00;RS

FF00 Attr.	Data Type	Access	Store & Default	SP for Windows Location	Description
RI	FE	RW	EE 0	System/ Interlocks	Reset Fan Failure Interlock When Fan Failure Interlock is enabled to shut down the fan (FF00;F3=1), setting RI=1 allows the fan to restart.
RE	FE	R	0	System/ Diagnostics	STATbus Reset Count increments each time a STATbus reset occurs. This attribute is used for diagnostic and troubleshooting purposes.
RS	FE	RW	RAM 0	System/ Power-up	Reset to reset the SBC-ASC(e): 0 = disabled (default), 1 = reset the SBC-ASC(e)
SN	FE	R	EE factory set	System/ About	Serial Number displays the serial number of the SBC-ASC(e) controller

OUTSIDE TEMPERATURE CHANNEL, FE09

FE09 Attr.	Data Type	Access	Store & Default	SP for Windows Location	Description
CV	FD	R RW if OI = 1	N/A	Temperature/ Outside	Outside Temperature shows the current value of OAT
OF	FD	RW	0.0	Temperature/ Outside	Outside Temperature Adjustment defines an offset used to adjust FE08; CV
OI	FE	RW	0	Temperature/ Outside	Override Outside Temperature when set to 1 this allows the outside temperature value (FE09; CV) to be altered manually
RE	FE	R	N/A	Temperature/ Outside	Channel Reliability indicates whether or not the OAT value can be trusted 0 = reliable 1 = unreliable

SUPPLY TEMPERATURE CHANNEL, FE08

FE08 Attr.	Data Type	Access	Store & Default	SP for Windows Location	Description
CV	FD	R RW IF OI = 1	N/A	Tempera ture/ Supply	Supply Temperature shows the current value of source/duct temperature.
DD	FD	RW	2.5	Tempera ture/ Supply	Auto Mode Deadband defines the temperature difference by which the supply air must either exceed FE00; HC to switch to heating mode, or fall below FE00; CC to engage cooling mode
OF	FD	RW	0.0	Tempera ture/ Supply	Supply Temperature Adjustment defines an offset used to adjust FE08; CV
OI	FE	RW	0	Tempera ture/ Supply	Override Supply Temperature when set to 1 this allows the supply temperature value to be altered manually
RE	FE	R	N/A	Tempera ture/ Supply	Channel Reliability indicates whether or not the supply /duct temperature value can be trusted 0 = reliable 1 = unreliable
SM	RE	R	N/A	Tempera ture/ Supply	Supply Mode indicates the current supply mode (cooling or heating)

UNIVERSAL INPUT CHANNEL, FE01-
FE05

FE01 - FE05 Attr.	Data Type	Access	Store & Default	SP for Windows Location	Description
CV	FD	RW	RAM NA	I/O Setup/ Input (UI1)	Current Value shows the current value
DT	FE	RW	EE 253	I/O Setup/ Input (UI1)	Data Type for Input specifies the PUP data type for the input
HL	FD	RW	EE 0.0	I/O Setup/ Input (UI1)	High Alarm Limit if alarms are enabled and the current value rises above this value, a high limit alarm will be generated
HS	FD	RW	EE 0.0	I/O Setup/ Input (UI1)	Alarm Limit Hysteresis determines when the SBC-ASC(e) returns from a high or low limit alarm
IF	FE	RW	EE 0.0	I/O Setup/ Input (UI1)	Input Filter Delay specifies the amount of time in tenths of seconds during which an input configured as digital input must remain stable for the value to be considered reliable
IP	FE	RW	EE 0	I/O Setup/ Input (UI1)	Input Polarity specifies the input polarity when the input is configured as a digital input 0 = normal 1 = reverse
LL	FD	RW	EE 0.0	I/O Setup/ Input (UI1)	Low Alarm Limit specifies the maximum engineering unit for the input corresponding to the highest value measured at the input connection 0 = normal 1 = reverse
MN	FD	RW	EE 0.0	I/O Setup/ Input (UI1)	Minimum Scaled Value specifies the minimum engineering unit for the input corresponding to the lowest value measured at the input connection
MX	FD	RW	EE 0.0	I/O Setup/ Input (UI1)	Maximum Scaled Value specifies the minimum engineering unit for the input corresponding to the lowest value measured at the input connection

FE01 - FE05 Attr.	Data Type	Access	Store & Default	SP for Windows Location	Description
OI	FE	RW	EE 0	I/O Setup/ Input (UI1)	Override Input allows a host or operator to directly set the value of the source/duct temperature
RE	FE	R	RAM NA	I/O Setup/ Input (UI1)	Data Reliability an analog input value is considered unreliable if it is out of range for the selected sensor type
ST	FE	RW	EE 7	I/O Setup/ Input (UI1)	Sensor Type selects one of the following input types: 0= digital 2= full scale, linear -5V dc or 0-20mA scaled from MN to MX 3= 4-20mA liner scaled from MN to MX 7= -22.0 to 122.0°F thermistor 1,4,5, and 6 unused
SU	FD	RW	EE 0.0	I/O Setup/ Input (UI1)	Amount of Setup/Setback Alarm Limit specifies the amount added to FE04;HL or subtracted from FE04;LL during unoccupied periods
AE	FE	RW	EE 0	I/O Setup/ Input (UI1)	Alarm Enable specifies the type of alarm checking to be done on the FE04;CV value 0=disabled 1= contact (0→1) 2=contact (1→0) 3=change of state (1↔0) 4=low limit alarm 5=high limit alarm 6=low and high limit
AS	FE	R	RAM 0	I/O Setup/ Input (UI1)	Alarm Status shows the current alarm condition 0=normal 1=contact (0→1) 2=contact (1→0) 3=change of state 4=unused 5=low limit alarm 6=high limit alarm

ZONE TEMPERATURE CHANNEL, FE00

FE00 Attr.	Data Type	Access	Store & Default	SP for Windows Location	Description
ZT	FD	RW (W if FE00; OI = 1)	RAM NA	Temperature/ Thermostat	Zone Temperature shows the current temperature value measured by the thermostat as adjusted by FE00;OF
AE	FE	RW	EE 0	Temperature/ Alarms	Enable Alarming specifies the type of alarm checking to be done on the CV value 0=disabled 4=low limit alarm 5=high limit alarm 6=low and high limit 1-3 and 7-12 are unused
AS	FE	R	RAM 0	Temperature/ Alarms	Alarm Status shows the current alarm condition 0=normal 5=low limit 6=high limit 1-4 and 7-12 are unused
BM	FE	RW	0	Temperature/ Sensor Bus	Bus Mode should be set to Master (FE00;BM=0) unless multiple controllers are wired onto a SSB. Any additional controllers on the SSB must be configured as Slaves (FE00;BM=1).
BT	FE	RW	EE 1 cooling only	Temperature/ Thermostat	Control Mode this attribute specifies the type of VAV terminal box being used 0 = none 1 = cooling only 2 = heating only 3 = supply dependant
CC	FD	R	RAM NA	Temperature/ Cooling Setpoints	Current Setpoint this attribute shows the current cooling control setpoint
CH	FD	R	RAM	Temperature/ Heating Setpoints	Current Setpoint this attribute shows the current heating control setpoint
CV	FD	RW	RAM NA	Temperature/ Alarms	Current Value shows the current value of the input

FE00 Attr.	Data Type	Access	Store & Default	SP for Windows Location	Description
DF	RE	RW	EE 3 ###.#	Temperature/ Sensor Bus	Display Format defines the format used to display the current temperature on the digital thermostat. The display of the tenths digit and the Fahrenheit/Celsius character are options. Also, the display may be eliminated. 0 = ##d 1 = ##.#d 2 = ##dF 3 = ##.#dF 4 = None
DL	FD	R	NA	Temperature/ Thermostat	Demand Load indicates the heating/cooling demand in terms of the temperature separation from setpoints
DM	FE	R	NA	Temperature/ Thermostat	Zone Demand indicates the demand for the zone 0 = vent 1 = cool 2 = heat
DS	FE	RW	EE 0 °F	Temperature/ Sensor Bus	Display Mode specifies whether English or Metric units are to be used for the digital thermostat display 0 = Fahrenheit 1 = Celsius
DV	FE	RW	0	Temperature/ Sensor Bus	Display Value , when FE00;DV=0 each digital thermostat displays the identical temperature value (average) (FE00;ZT). When FE00;DV=1 each thermostat displays its own temperature
ED	FE	RW	EE 60 minute s	Temperature/ Override	Extended Occupancy Duration this attribute specifies the amount of time, in minutes, to extend occupancy
ER	FE	R	RAM NA	Temperature/ Override	Extended Occupancy Remaining this attribute shows the amount of time remaining in extended occupancy
G0	FE	R	RAM	Temperature/ Sensor Bus	GID Device 0 is the global identification for the SSB device
G1	FE	R	RAM	Temperature/ Sensor Bus	GID Device 1 is the global identification for the SSB device

FE00 Attr.	Data Type	Access	Store & Default	SP for Windows Location	Description
G2	FE	R	RAM	Temperature/ Sensor Bus	GID Device 2 is the global identification for the SSB device
G3	FE	R	RAM	Temperature/ Sensor Bus	GID Device 3 is the global identification for the SSB device
HL	FD	RW	EE 0.0	Temperature/ Alarms	High Alarm Limit if alarms are enabled and the current value rises above this value, a high limit alarm will be generated
HS	FD	RW	EE 0.0	Temperature/ Alarms	Alarm Limit Hysteresis determines when the SBC-ASC(e) returns from a high or low limit alarm
LL	FD	RW	EE 0.0	Temperature/ Alarms	Low Alarm Limit if alarms are enabled and the current value drops below this value, a low limit alarm will be generated
NC	FD	RW	EE 5.0	Temperature/ Cooling Setpoints	Night Setback specifies, in +/- degrees, the amount to be added to the cooling setpoint (FE00;SC) when the SBC-ASC(e) is in night setback mode
NH	FD	RW	EE 10.0°F	Temperature/ Heating Setpoints	Night Setback this attribute specifies, in +/- degrees, the amount to be added to the heating setpoint (FE00;SH) when the SBC-ASC(e) is in night setback mode
OF	FD	RW	EE 0	Temperature/ Thermostat	Temperature Correction this defines the correction that is being applied to temperature readings
OI	FE	RW	EE 0	Temperature/ Thermostat	Override Temperature Value when set to 1, it allows you to write to FE00;ZT directly
PB	FE	RW	EE 2200	Temperature/ Sensor Bus	Balancer P.I.N. this personal identification number controls access to the Balance Menu

FE00 Attr.	Data Type	Access	Store & Default	SP for Windows Location	Description
PG	FE	RW	EE	Temperature/ Sensor Bus	Primary GID specifies the GID of the Primary SBC-STAT in Primary GID mode (RM=8). If this SBC-STAT is not available then the Average temperature mode (RM=0) is used.
PI	FE	RW	EE 3300	Temperature/ Sensor Bus	Installer P.I.N. this Personal Identification Number controls access to all menus.
PS	FE	RW	EE 1100	Temperature/ Sensor Bus	Service P.I.N. this personal identification number controls access to the Service Menu
PU	FE	RW	EE 0	Temperature/ Sensor Bus	User P.I.N. this personal identification number controls access to the User Menu
RD	FD	RW	15.0	Temperature/ Thermostat	Reversing Delay specifies the delay, in minutes, imposed before a heating after a period of cooling, or cooling after a period of heating
RM	FE	RW	EE 0 Average	Temperature/ Sensor Bus	Reading Mode specifies the technique used to determine Zone Temperature when multiple SBC-STATs are used. 0 = Average 1 = Highest 2 = Lowest 3 = Hi/Lo VST mode 4-7 = Device 0-Device 3 8 = Primary GID
SC	FD	RW	EE 72.0	Temperature/ Cooling Setpoints	Cooling Setpoint shows the zone temperature setpoint desired to begin cooling control
SD	FE	RW	EE 0	Temperature/ Setpoint Adjust	Calculated Setpoint Display Users can select a method of setpoint adjustment that is displayed when users adjust the setpoint on an SBC-STAT3.
SE	FE	RW	EE 1 enabled	Temperature/ Override	User Override this attribute enables or disables your ability to enter extended occupancy override 0 = disabled 1 = enabled

FE00 Attr.	Data Type	Access	Store & Default	SP for Windows Location	Description
SH	FD	RW	EE 68.0°F	Temperature/ Heating Setpoints	Heating Setpoint this attribute shows the zone temperature setpoint desired to begin heating control
SU	FE	RW	EE 0.0	Temperature/ Alarms	Amount to Setup/ Setback Alarm Limit specifies the amount added to HL or subtracted from LL during unoccupied periods
SW	FD	RW	EE 72.0°F	Temperature/ Heating Setpoints	Warm-up Setpoint shows the zone temperature setpoint desired for beginning warm-up heating control
T0	FD	R	RAM	Temperature/ Sensor Bus	Reading Device 0 is the raw reading for Device 1 on a SSB
T1	FD	R	RAM	Temperature/ Sensor Bus	Reading Device 1 is the raw reading for Device 2 on a SSB
T2	FD	R	RAM	Temperature/ Sensor Bus	Reading Device 2 is the raw reading for Device 3 on a SSB
T3	FD	R	RAM	Temperature/ Sensor Bus	Reading Device 3 is the raw reading for Device 4 on a SSB
TM	FD	RW	EE 0.5°F	Temperature/ Setpoint Adjust	User Adjust Increment this attribute specifies the magnitude of incremental changes to the User Setpoint Offset (FE00;TS)
TP	FF	RW	RAM 0	Temperature/ Setpoint Adjust	User Adjust Position the User Setpoint Offset (FE00;TS) can be raised or lowered in integral steps; the FE00;TP attribute tracks the current step
TR	FE	RW	RAM 0	Temperature/ Setpoint Adjust	User Adjust Remaining displays the time remaining before the User Setpoint Offset (FE00;TS) setting is reset
TS	FD	R	RAM 0	Temperature/ Setpoint Adjust	User Setpoint Offset this attribute defines an offset to be applied to PID setpoints

FE00 Attr.	Data Type	Access	Store & Default	SP for Windows Location	Description
TT	FE	RW	EE 120 minutes	Temperature/ Setpoint Adjust	User Setpoint Offset the User Setpoint Offset (FE00;TS) is a temporary setting; the FE00;TT attribute defines in minutes the duration for which the setting applies
UC	FD	RW	EE 5.0	Temperature/ Cooling Setpoints	Unoccupied Setback this attribute specifies, +/- degrees, the amount to be added to the cooling setpoint (FE00;SC) when the SBC-ASC(e) schedule is in unoccupied mode
UH	FD	RW	EE 10.0°F	Temperature/ Heating Setpoints	Unoccupied Setback specifies, in +/- degrees, the amount to be added to the heating setpoint (FE00;SH) when the SBC-ASC(e) is in unoccupied mode
ZS	FD	RW	RAM 70.0	Temperature/ Setpoint Adjust	Zone Midpoint displays the midpoint between the current cooling and heating setpoints.
RH	FD	R	RAM	Aux/Relative Humidity	Relative Humidity displays the current sensed humidity from a connected SBC-RHT thermostat.
HD	FE	RW	EE 0	Aux/Relative Humidity	Display Relative Humidity Indicates if RH should be displayed on the LCD of a connected SBC-RHT.
HC	FD	RW	EE 0.0	Aux/Relative Humidity	Relative Humidity Correction defines a correction offset for relative humidity.
HO	FE	RW	EE 0	Aux/Relative Humidity	Override Relative Humidity defines whether or not to override the current sensed relative humidity.

ANALOG OUTPUT CHANNEL, FD01- FD04

FD01 - FD04 Attr.	Data Type	Access	Store & Default	SP for Windows Location	Description
CV	FC	RW	RAM 0.0	I/O Setup/ Output (AO1)	Current Output Value shows the current value of the analog output
DT	FE	RW	EE 252	I/O Setup/ Output (AO1)	Data Type for Output specifies the PUP data type for the analog output
HS	FA	RW	EE 100.0	I/O Setup/ Output (AO1)	Maximum Scaled Voltage specifies the actual analog output value for a FD01; CV value of FD01; MX
LS	FA	RW	EE 0.00	I/O Setup/ Output (AO1)	Minimum Scaled Voltage specifies the actual analog output value for a FD01; CV value of FD01; MN
MN	FC	RW	EE 0.0	I/O Setup/ Output (AO1)	Minimum Scaled Value specifies the minimum scaled value for the analog output corresponding to the lowest value output
MX	FC	RW	EE 100.0	I/O Setup/ Output (AO1)	Maximum Scaled Value specifies the maximum scaled value for the analog output corresponding to the highest value output
AM	FE	RW	EE 0	I/O Setup/ Output (AO1)	Automatic/Manual Control selects the control mode for the analog output

PULSE CHANNEL, FC03

FC03 Attr.	Data Type	Access	Store & Default	SP for Windows Location	Description
CV	FE	R	RAM	Aux/ Pulse Channel	Current State reports the current status, 0 or 1, for the binary inputs
MD	FE	RW	0 EE	Aux/ Pulse Channel	Counter Mode select an option for the counter 0 = Disabled 1 = falling edges 2 = enabled to count on signal rising edges 3 = both edges
NP	FE	RW	RAM	Aux/ Pulse Channel	Pulse Count reports the count of detected edges. To clear or initialize the count, you can write to this attribute.
SF	F9	RW	0.000 EE	Aux/ Pulse Channel	Pulse Scale Factor the weighted value of each pulse count
SV	F9	R	0.000 RAM	Aux/ Pulse Channel	Pulse Scaled Value the product of the current pulse count and the pulse scale factor

FAN STATUS CHANNEL, FC02

FC02 Attr.	Data Type	Access	Store & Default	SP for Windows Location	Description
PF	FE	R	N/A RAM	Aux/Fan Status	Fan Status shows that status of the fan
IC	FE	RW	0 = None EE	Aux/Fan Status	Status Input selects the digital input where a non-zero value indicates flow
PD	FE	RW	60 EE	Aux/Fan Status	Delay shows the amount of time, in seconds, imposed before enabling a positive flow indication

OCCUPANCY DETECTOR CHANNEL, FC01

FC01 Attr.	Data Type	Access	Store & Default	SP for Windows Location	Description
MS	FE	R	RAM NA	Aux/ Occupa ncy Detector	Occupancy Status shows the status of the occupancy detector digital input
MT	FE	RW	EE 0	Aux/ Occupa ncy Detector	Extended Occupancy Duration defines, in minutes, the length of time to override the zone whenever occupancy is detected
IC	FE	RW	EE 0	Aux/ Occupa ncy Detector	Status Input selects which input to use 0 = None 1 = UI1 2 = UI2 3 = UI3 4 = UI4 5 = UI5 6 = OIA/B
MD	FE	RW	EE 30	Aux/ Occupa ncy Detector	Extended Occupancy Delay sets the amount of time, in seconds, during which the occupancy detector must remain on before it will override the zone
MR	FE	R	RAM NA	Aux/ Occupa ncy Detector	Extended Occupancy Remaining displays the time remaining for occupancy detector override

DIGITAL OUTPUT CHANNEL (K1-
K5), FB01-FB05

FB01 - FB05 Attr.	Data Type	Access	Store & Default	SP for Windows Location	Description
CV	FE	RW	RAM NA	I/O setup/ Relay Outputs	Current Output Value shows the current value for the analog output
OI	FE	RW	EE 0 Off	I/O setup/ Relay Outputs	Override overrides the digital output. On (OI = 1) constantly energizes the output; Off (OI = 0) disables the output; Auto (OI = 2) allows for automatic control; Manual (OI = 3) allows the CV to be directly written. The factory default setting is OI = 1 (Off) to allow full configuration before equipment operation. Each digital output must be manually enabled.
OP	FE	RW	EE 0	I/O setup/ Relay Outputs	Output Polarity allows you to change the polarity of the output 0 = normal 1 = reverse
RH	FC	RW	*	I/O setup/ Relay Outputs	Runtime Hours shows the total amount of time, in hours, during which the output has been energized
RL	FC	RW	EE 0.0	I/O setup/ Relay Outputs	Runtime Limit specifies a run time limit in hours for the output

COOLING/HEATING STAGE 2, FB04

FB04 Attr.	Data Type	Access	Store & Default	SP for Windows Location	Description
CV	FE	R	0 = Off RAM	Equipme nt/Stage 2	Stage 2 indicates the status of the stage output.
HO	FD	RW	2.0 EE	Equipme nt/Stage 2	Heating Staging Delay indicates the temperature offset from setpoint required before engaging the stage for Heating. Note that the stage may also engage if the Staging Delay for the prior stage expires.
HR	FD	RW	3.0 EE	Equipme nt/Stage 2	Heating DAT High Temp Lockout shows the minimum amount of time, in minutes, the stage will stay energized when heating.
HS	FD	RW	7.0 EE	Equipme nt/Stage 2	Heating OAT Lockout shows the minimum amount of time, in minutes, the stage will remain de-energized when heating.
CO	FD	RW	2.0 EE	Equipme nt/Stage 2	Cooling Temp Offset indicates the temperature offset from setpoint required before engaging the stage for Cooling. Note that the stage may also engage if the Staging Delay for the prior stage expires.
CR	FD	RW	3.0 EE	Equipme nt/Stage 2	Cooling Min Run Time shows the minimum amount of time, in minutes, the stage will stay energized when cooling.
CS	FD	RW	7.0 EE	Equipme nt/Stage 2	Heating Min Off Time shows the minimum amount of time, in minutes, the stage will remain de-energized when cooling.

*Run hours are automatically backed up at midnight; restoration occurs when the unit is powered up after loss of power or after a reset.

COOLING/HEATING STAGE 1, FB03

FB03 Attr.	Data Type	Access	Store & Default	SP for Windows Location	Description
CV	FE	R	0 = Off RAM	Equipment /Stage 1	Stage 1 indicates the status of the stage output.
CX	FC	RW	20.0 EE	Equipment /Stage 1	Cooling Staging Delay indicates the maximum amount of time, in minutes, that the cooling stage will operate before energizing the next stage of cooling.
HL	FD	RW	80.0 EE	Equipment /Stage 1	Heating OAT Lockout heating stages will not be engaged if a Reliable (FE09;RE=0) Outside Air Temperature (FE09;CV) is available that is above the temperature specified by this attribute. Stages will not be de-energized should the OAT rise above this temperature during an active cycle.
HO	FD	RW	0.0 EE	Equipment /Stage 1	Heating Temp Offset indicates the temperature offset from setpoint required before engaging the stage for Heating. Note that the stage may also engage if the Staging Delay for the prior stage expires.
HR	FD	RW	3.0 EE	Equipment /Stage 1	Heating Min Run Time shows the minimum amount of time, in minutes, the stage will stay energized when heating.
HS	FD	RW	7.0 EE	Equipment /Stage 1	Heating Min Off Time shows the minimum amount of time, in minutes, the stage will remain de-energized when heating.
HX	FD	RW	20.0 EE	Equipment /Stage 1	Heating Staging Delay indicates the maximum amount of time, in minutes, that the heating stage will operate before energizing the next stage of heating.
TH	FD	RW	105.0 EE	Equipment /Stage 1	Heating DAT High Temp Lockout heating stages will be engaged only if there is a reliable source/duct temperature (DAT) below this setting.
TL	FC	RW	45.0 EE	Equipment /Stage 1	Cooling DAT Low Temp Lockout cooling stages will be engaged only if there is a reliable source/duct temperature (DAT) below this setting.

FB03 Attr.	Data Type	Access	Store & Default	SP for Windows Location	Description
CL	FD	RW	55.0 EE	Equipment /Stage 1	Cooling OAT Lockout heating stages will not be engaged if a Reliable (FE09;RE=0) Outside Air Temperature (FE09;CV) is available that is above the temperature specified by this attribute. Stages will not be de-energized should the OAT rise above this temperature during an active cycle.
CO	FD	RW	0.0 EE	Equipment /Stage 1	Temp Offset indicates the temperature offset from setpoint required before engaging the stage for Cooling.
CR	FD	RW	3.0 EE	Equipment /Stage 1	Cooling Min Run Time shows the minimum amount of time, in minutes, the stage will stay energized when cooling.
CS	FC	RW	7.0 EE	Equipment /Stage 1	Cooling Min Off Time shows the minimum amount of time, in minutes, the stage will remain de-energized when cooling.

REVERSING VALVE, FB02

FB02 Attr.	Data Type	Access	Store & Default	SP for Windows Location	Description
CV	FE	RW	0 = Cooling RAM	Equipment/ Reversing Valve	Reversing Valve Mode indicated the heating or cooling status of the reversing valve 0 = cooling 1 = heating
SD	FE	RW	180 EE	Equipment/ Reversing Valve	Settling Delay specifies a delay period, in seconds, that is imposed both before and after the reversing valve state is changed. The delay begins once all stages have been shut down. The stages will not energize for this period after the valve state is changed.
IN	FE	RW	0 = Unused EE	Equipment/ Reversing Valve	Defrost Input Select selects what input to use to control the defrost cycle. If set to "Unused", the defrost cycle is not active.
FB	FE	RO	0 = Inactive EE	Equipment/ Reversing Valve	Defrost Status Indicates if the defrost logic is active, and if a cycle is in progress.
ES	FD	RW	0.0 EE	Equipment/ Reversing Valve	Enter Defrost Cycle Setpoint defines the temperature that the coils must be cooled to for the defrost cycle to engage.
XS	FD	RW	0.0 EE	Equipment/ Reversing Valve	Exit Defrost Cycle Setpoint defines the temperature at which point the defrost cycle will terminate.
PT	FD	RW	0.0 EE	Equipment/ Reversing Valve	Defrost Programmed Time Between Cycles defines the initial time period (in minutes) from the end of one cycle to the start of the next. The actual time may be adjusted automatically.
AT	FD	RO	0.0 RAM	Equipment/ Reversing Valve	Defrost Adjusted Time Between Cycles defines an adjustment made to PT based on previous cycles. If the previous cycle does not raise the temperature up to XS, then the controller will reduce the time before the next cycle. If the previous cycle completed quickly (faster than 25% of MC), the time is increased.

FB02 Attr.	Data Type	Access	Store & Default	SP for Windows Location	Description
MC	FD	RW	0.0 EE	Equipment/ Reversing Valve	Defrost Max. Cycle Time defines the maximum amount of time, in minutes, that a defrost cycle will last.
LT	FD	RO	0.0 RAM		Defrost Time Until Next Action indicates the amount of time, in minutes, remaining before the defrost cycle will look to perform the next action.

FAN DIGITAL OUTPUT CHANNEL (K1), FB01

FB01 Attr.	Data Type	Access	Store & Default	SP for Windows Location	Description
CV	FE	RW	RAM NA	Equipment/ Fan	Fan defines the status of the fan output
FD	FE	RW	30	Equipment/ Fan	Shutoff Delay shows the amount of time, in seconds, the fan output will stay energized once the zone temperature reaches the deadband
FN	FE	RW	0	Equipment/ Fan	Night Setback Mode defines the mode of the fan during the night setback schedule state. When FN = 1, the fan runs for the entire period. When FN = 0, the fan shuts off when the zone temperature is within the deadband.
FO	FE	RW	EE 0	Equipment/ Fan	Occupied Mode defines the mode of the fan during the occupied schedule state. When FO = 1, the fan runs for the entire period. When FO = 0, the fan shuts off when the zone temperature is within the deadband.
FR	FD	FW	0.5	Equipment/ Fan	Minimum Run Time shows the minimum amount of time, in minutes, the fan output will stay energized
FS	FD	RW	1.0	Equipment/ Fan	Minimum Off Time shows the minimum amount of time, in minutes, the fan output will stay de-energized

PID CONTROL CHANNEL, FA11-FA14

FA11 - FA14 Attr.	Data Type	Access	Store & Value	SP for Windows Location	Description
AO	FC	RW	RAM NA	Aux/PID Control	Analog Output Value shows the scaled output value used by the analog output
CE	FE	RW	EE 0	Aux/PID Control	Enable Control Loop enables the PID loop
CS	FD	R	RAM NA	Aux/PID Control	Calculated Control Setpoint shows the actual loop control setpoint
DB	FC	RW	EE 0	Aux/PID Control	Deadband specifies the input variable range in which no control action occurs
IC	FE	RW	EE 0	Aux/PID Control	Loop Measured Variable specifies the input to be used for the measured variable for the control loop 0= disabled 1=Zone Temp 2=Supply Temp 4=U1 5=U2 6=U3 7=U4 8=U5 9=Zone Heating 10=Zone Cooling 11=Outside Air Temperature 13=Relative Humidity
ID	FE	RW	EE 0	Aux/PID Control	Interlock Enable/Disable enables/disables the interlocks for the PID. When an interlock input is = 1 (enabled), the PID control output is set to the value of the interlock failure position.
IN	FC	R	RAM 0	Aux/PID Control	Measured Variable's Value displays the value of the input selected in FA04;IC
MR	FC	RW	EE 0	Aux/PID Control	Maximum Amount to Reset Setpoint specifies the maximum amount by which to reset the loop setpoint (SP) when reset is being used
PB	FC	RW	EE 0	Aux/PID Control	Proportional Band specifies the input variable range over which the output value is proportional to the error value

FA11 - FA14 Attr.	Data Type	Access	Store & Value	SP for Windows Location	Description
PO	FC	R	RAM NA	Aux/PID Control	Percent Output Value shows the output value in hundredths of a percent
P1	FC	RW	EE 0	Aux/PID Control	Interlock 1 Position specifies the PID output value when Interlock 1 is active and enabled.
P2	FC	RW	EE 0	Aux/PID Control	Interlock 2 Position specifies the PID output value when Interlock 2 is active and enabled.
P3	FC	RW	EE 0	Aux/PID Control	No Flow Position specifies the PID output value when the current value of Fan Status is equal to 0 (No Flow).
RC	FC	R	RAM NA	Aux/PID Control	Reset Variable's Value displays the value of the input selected in RV
RL	FC	RW	EE 0	Aux/PID Control	Limit for Maximum Reset specifies the value at which maximum reset is used
RP	FE	RW	EE 0	Aux/PID Control	Reset Period specifies the reset period (in seconds) over which the error history is accumulated
RS	FC	RW	EE 0	Aux/PID Control	Setpoint at Which Reset Action Begins specifies the value at which the reset action begins
RT	FC	RW	EE 0	Aux/PID Control	Derivative Rate specifies a percentage of change in error that is to be used in calculating FA04;PO
RV	FE	RW	EE 0	Aux/PID Control	Reset Variable specifies the input to be used for calculating the reset 0=disabled 1=Zone Temp 2=Supply Temp 4=U1 5=U2 6=U3 7=U4 8=U5 11=Outside Air Temperature 13=Relative Humidity
SG	FE	RW	EE 0	Aux/PID Control	Control Action specifies the control action for the control loop 0 = normal 1 = reverse
SP	FD	RW	EE 0	Aux/PID Control	Loop Setpoint specifies the desired loop setpoint

FA11 - FA14 Attr.	Data Type	Access	Store & Value	SP for Windows Location	Description
SU	FC	RW	EE 0	Aux/PID Control	Unoccupied Setup/ Setback specifies the amount to add (if SG = 0) or subtract (if SG = 1) from the setpoint during an unoccupied period

SCHEDULE 1 THROUGH SCHEDULE 6 CHANNEL, F901-F906

F901 - F906 Attr.	Data Type	Access	Store & Default	SP for Windows Location	Description
CV	FE	R	RAM NA	Schedul es/1-6	Current Schedule Value indicates the current state of the schedule: 0 = unoccupied mode, 1 = warm-up, 2 = occupied mode, 3 = night setback
NS	E6	RW	EE 19:00	Schedul es/1-6	Night Setback start time in short military format when night setback should begin
OC	E6	RW	EE 08:00	Schedul es/1-6	Occupied Time start time in short military format when occupied mode should begin
UN	E6	RW	EE 17:00	Schedul es/1-6	Unoccupied Time start time in short military format when unoccupied mode should begin
WO	E6	RW	EE 07:00	Schedul es/1-6	Warm-up Time start time in short military format when warm-up mode should begin
AD	E9	RW	EE M T W T F	Schedul es/1-6	Active Days Day-of-week map specifying which of eight possible days of the week (seven days plus holiday) that the schedule is active 0 = Monday 1 = Tuesday 2 = Wednesday 3 = Thursday 4 = Friday 5 = Saturday 6 = Sunday 7 = Holiday
AO	FE	RW	EE 0	Schedul es/1-6	All-Day Override this attribute is used to override the schedule in WO, OC, UN, and NS for active days 0 = none 1 = unoccupied 2 = warm-up 3 = occupied 4 = night setback

ECONOMIZER CHANNEL, FA01

FA01 Attr.	Data Type	Access	Store & Default	SP for Windows Location	Description
EE	FE	RW	EE 0	Auxiliary/ Economizer	Economizer Enable specifies the PID channel or DO to be used for economizer control. 0=Off 1=PID 1 2=PID 2 3=PID 3 4=PID 4 5=DO 3 6=DO 5
OH	FD	RW	EE 60.0	Auxiliary/ Economizer	OAT High Limit If the OAT is above the high limit and the economizer is enabled, the PID is set to the Minimum Position (as specified in FA01; EM).
OL	FC	RW	EE 45.0	Auxiliary/ Economizer	OAT Low Limit If the OAT is below the low limit and the economizer is enabled, the PID is set to the Minimum Position (as specified in FA01; EM).
EM	FC	RW	EE 10.0	Auxiliary/ Economizer	Minimum Position specifies the PID minimum position in percent for the economizer damper.
ED	FC	RW	EE 1.0	Auxiliary/ Economizer	Economizer Staging Delay Specifies how many minutes the controller waits before using additional cooling stages after the economizer damper reaches 100%.
CM	FC	RW	RAM N/A	Auxiliary/ Economizer	Calculated Minimum Position displays the actual minimum position of the economizer damper
MV	FC	RW	EE 0	Auxiliary/ Economizer	Reset variable allows you to specify an input sensor that is to be used to reset the minimum position of the economizer (FA01; EM).
MP	FC	RW	EE 0	Auxiliary/ Economizer	Reset Setpoint Specifies the value at which the reset action begins. When the value of the reset variable exceeds MP , reset action will be used in determining the economizer minimum position.

FA01 Attr.	Data Type	Access	Store & Default	SP for Windows Location	Description
MR	FC	RW	EE 0	Auxiliary/ Economizer	Maximum Reset specifies the maximum amount by which to reset the minimum position setpoint (EM) when reset is being used.
ML	FC	RW	EE 0	Auxiliary/ Economizer	Reset Limit When the value of the reset variable is equal to ML , the maximum reset (MR) is used in determining the calculated minimum position.

NETWORK BROADCAST CHANNEL,
F005

F005	Data Type	Access	Store & Default	SP for Windows Location	Description
CV	FE	R	RAM 0	Network/ Schedule Broadcas t	Current Value shows the current value of the network broadcast schedule values received by the SBC-ASC(e)
RB	FE	RW	EE 0	Network/ Schedule Broadcas t	Receive Broadcast enables the SBC-ASC(e) to receive network broadcasts and sets the F900; CV value based on the received value

OUTSIDE AIR TEMPERATURE (OAT)
CHANNEL, F000

F000	Data Type	Access	Store & Default	SP for Windows Location	Description
CV	FE	R	RAM 0	Network/ OAT Broadcas t	Current Value shows the current value of the network broadcast schedule values received by the SBC-ASC(e)
RB	FE	RW	EE 0	Network/ OAT Broadcas t	Receive Broadcast enables the SBC-ASC(e) to receive network broadcasts and sets the F900; CV value based on the received value
BE	FE	RW	0	Network/ OAT Broadcas t	Broadcast Enable enables active broadcast of a reliable FE09; CV Outside Air Temperature (OAT)

APPENDIX C: FAN COIL PUP CHANNELS AND ATTRIBUTES

The following tables contain a list of Public Unitary Protocol (PUP) attribute and channel assignments for the Fan Coil application. Each attribute is given with its PUP channel assignment, PUP data type, access code, where it is stored, its SoloPro for Windows location, and a brief description.

SYSTEM CHANNEL, FF00

FF00 Attr.	Data Type	Access	Store & Default	SP for Windows Location	Description
SR	FE	R	Flash	System/About	Flash Release Code uniquely defines each flash firmware image
TF	FE	RW	EE 0	System/Interlocks	Time in Fire number of minutes the SBC-ASC remains in fire mode upon receipt of a "Change Operation Mode" broadcast. If TF = 0, the SBC-ASC will remain in fire mode until the controller is reset. If TF = 255, then the SBC-ASC will not accept "Change of Mode" broadcasts.
TP	FE	RW	EE 0 Irresponsible Peers	Network/Configuration	Token Passing Type defines the mode for token passing. When a controller is an Irresponsible Peer it will always return a token to the device that passed it, after performing any pending transactions. In Full Administrator mode, the token is passed to each unit listed in the Peer List (FF00;U1 through FF00;U4). 0 = irresponsible peer 1 = full administrator
U1-U4	FE	RW	EE 65535	Network/Configuration	Peer Unit Number defines the Unit ID of a peer. In Full Administrator mode the token is passed to each unit in the Peer List.
UP	FE	R	0	System/Diagnostics	Flash Update Count increments each time a new flash firmware image is accepted by the controller.
VE	FA	R	Flash 0	System/About	Version Number contains the factory-set firmware version

FF00 Attr.	Data Type	Access	Store & Default	SP for Windows Location	Description
WC	FE	R	0	System/Diagnostics	Watchdog Count increments upon firmware failure but can also be advanced during the removal of power
ZN	FE	RW	EE 0	Network/Configuration	Zone Number from 0 to 65,535 used to group controllers so that they can be controlled simultaneously
ZP	FE	RW	0	System/Diagnostics	MMT Pulse Count advances when MMT takes action to maintain the operation of the actuator
BU	FE	RW	RAM 0	System/Power-up	Back Up RAM Values copies specific attribute values from RAM to EEPROM when set to 1: 0 = normal operation, 1 = back up RAM to EEPROM
CC	FE	RW	0	System/Diagnostics	Clock Fail Count increments upon hardware failure but can also be advanced during the removal of power
CM	FE	R	Flash 255	System/About	Controller Manufacturer contains the factory-set manufacturer number for the unitary controller
CP	FE	RW	EE 0	Network/Configuration	Communication Speed specifies the communication speed (baud rate) at which devices on this network will communicate 0=9600 1=4800 2=2400 3=1200 4=reserved 5=reserved 6=38.4K 7=19.2K 8=115.2K 9=57.6K

FF00 Attr.	Data Type	Access	Store & Default	SP for Windows Location	Description
CT	FE	R	Flash 101	System/About	Controller Type factory-set controller type identifies the type of unitary controller
DE	FE	RW	RAM	System/Power-up	Default Enable this attribute is used to restore configuration settings to factory defaults
EM	FE	RW	EE 0	System/About	English/Metric specifies which units of measurement to use in returning temperature and airflow values: 0 = English Units; 1 = Metric Units
ER	FE	RW	EE 0 Disabled	Network/Configuration	Token Recovery enables Token Recovery. In a token passing environment there should always be network activity, but if a token is lost the network will fall silent. If Token Recovery is enabled, and a token is lost, Full Administrator will detect the condition and initiate a new token. 0 = disabled 1 = enabled
FT	FE	R	Flash 6	System/About	Firmware Type defines the class of firmware operating system used in this controller
F1	FE	RW	EE 0	System/Interlocks	Fan Failure Interlock Trips Fan? When F1 is set to 0, Interlock 1 will not trip the fan. When set to 1 and Interlock 1 is active, the fan is shut down.
F2	FE	RW	EE 0	System/Interlocks	Fan Failure Interlock Trips Fan? When F2 is set to 0, Interlock 2 will not trip the fan. When set to 1 and Interlock 2 is active, the fan is shut down.
F3	FE	RW	EE 0	System/Interlocks	Fan Failure Interlock Trips Fan? When F3 is set to 0, Interlock 3 will not trip the fan. When set to 1 and Interlock 3 is active, the fan is shut down.

FF00 Attr.	Data Type	Access	Store & Default	SP for Windows Location	Description
IC	FE	R	0	System/Diagnostics	EEPROM Default Count increments whenever the EEPROM is restored to factory default settings (see FF00:DE Default Enable)
ID	FE	RW	EE SN	Network/Configuration	Unit Number used to set a unique network address for each controller connected to a multidrop
IS	E9	R	RAM N/A	System/Interlocks	Interlock Status displays the status of all of the interlocks bit 0=interlock 1 bit 1=interlock 2 bit 2=interlock 3
I1	FE	RW	EE 0	System/Interlocks	Interlock 1 Channel specifies the input to be used for interlock 1. Disabling this input disables the PID interlock 1 0=Disabled 1=UI1 2=UI2 3=UI3 4=UI4 5=UI5 6=OIA/B
I2	FE	RW	EE 0	System/Interlocks	Interlock 1 Channel specifies the input to be used for interlock 1. Disabling this input disables the PID interlock 1 0=Disabled 1=UI1 2=UI2 3=UI3 4=UI4 5=UI5 6=OIA/B
I3	FE	RW	EE 0	System/Interlocks	Fan Failure Interlock used as a Proof of Flow interlock. 0=Disabled 1=Fan Status.
OC	FE	RW	0	System/Diagnostics	Illegal Opcode Count increments upon firmware failure but can also be advanced during the removal of power
PD	FE	RW	EE 5	System/Power-up	Power On Delay time delay in seconds (0–255) that must elapse after the SBC-ASC(e) is reset before output control or alarm functions can begin: 0 = no delay, 1–255 = delay specified in seconds

FF00 Attr.	Data Type	Access	Store & Default	SP for Windows Location	Description
PS	FE	RW	EE 2	System/ Power-up	Power Up State schedule state the SBC-ASC(e) will operate in when it is initially powered or the state that it will operate in when power is restored after a power failure 0=unoccupied 1=warmup 2=occupied 3=night setback
RC	FE	R	0	System/ Diagnostics	Power-up Count increments each time power is applied to the controller. This counts power outages and noise related resets as well as resets initiated through FF00;RS
RE	FE	R	0	System/ Diagnostics	STATbus Reset Count increments each time a STATbus reset occurs. This attribute is used for diagnostic and troubleshooting purposes.
RI	FE	RW	EE 0	System/ Interlocks	Reset Fan Failure Interlock When Fan Failure Interlock is enabled to shut down the fan (FF00;F3=1), setting RI=1 allows the fan to restart.
RS	FE	RW	RAM 0	System/ Power-up	Reset to reset the SBC-ASC(e): 0 = disabled (default), 1 = reset the SBC-ASC(e)
SN	FE	R	EE factory set	System/ About	Serial Number displays the serial number of the SBC-ASC(e) controller

OUTSIDE TEMPERATURE CHANNEL, FE09

FE09 Attr.	Data Type	Access	Store & Default	SP for Windows Location	Description
CV	FD	R RW if OI =	N/A	Temperature /Outside	Outside Temperature shows the current value of OAT
OF	RD	RW	0.0	Temperature /Outside	Outside Temperature Adjustment defines an offset used to adjust FE08;CV
OI	FE	RW	0	Temperature /Outside	Override Outside Temperature when set to 1 this allows the outside temperature value (FE09;CV) to be altered manually
RE	FE	R	N/A	Temperature /Outside	Channel Reliability indicates whether or not the OAT value can be trusted

SUPPLY TEMPERATURE CHANNEL, FE08

FE08 Attr.	Data Type	Access	Store & Default	SP for Windows Location	Description
CV	FD	R RW if OI =	N/A	Temperature /Supply	Supply Temperature shows the current value of source/ duct temperature.
DD	FD	RW	2.5	Temperature /Supply	Auto Mode Deadband defines the temperature difference by which the supply air must either exceed FE00;HC to switch to heating mode, or fall below FE00;CC to engage cooling mode
OF	FD	RW	0 0.0	Temperature /Supply	Supply Temperature Adjustment defines an offset used to adjust FE08;CV
OI	FE	RW	0	Temperature /Supply	Override Supply Temperature when set to 1 this allows the supply temperature value to be altered manually
RE	FE	R	N/A	Temperature /Supply	Channel Reliability indicates whether or not the supply / duct temperature value can be trusted
SM	FE	R	N/A	Temperature /Supply	Supply Mode indicates the current supply mode (cooling or heating)

UNIVERSAL INPUT CHANNEL, FE01-
FE05

FE01 - FE05 Attr.	Data Type	Access	Store & Default	SP for Windows Location	Description
CV	FD	RW	RAM NA	I/O Setup/ Input (UI1)	Current Value shows the current value
DT	FE	RW	EE 253	I/O Setup/ Input (UI1)	Data Type for Input specifies the PUP data type for the input
HL	FD	RW	EE 0.0	I/O Setup/ Input (UI1)	High Alarm Limit if alarms are enabled and the current value rises above this value, a high limit alarm will be generated
HS	FD	RW	EE 0.0	I/O Setup/ Input (UI1)	Alarm Limit Hysteresis determines when the SBC-ASC(e) returns from a high or low limit alarm
IF	FE	RW	EE 0.0	I/O Setup/ Input (UI1)	Input Filter Delay specifies the amount of time in tenths of seconds during which an input configured as digital input must remain stable for the value to be considered reliable
IP	FE	RW	EE 0	I/O Setup/ Input (UI1)	Input Polarity specifies the input polarity when the input is configured as a digital input 0 = normal 1 = reverse
LL	FD	RW	EE 0.0	I/O Setup/ Input (UI1)	Low Alarm Limit specifies the maximum engineering unit for the input corresponding to the highest value measured at the input connection
MN	FD	RW	EE 0.0	I/O Setup/ Input (UI1)	Minimum Scaled Value specifies the minimum engineering unit for the input corresponding to the lowest value measured at the input connection
MX	FD	RW	EE 0.0	I/O Setup/ Input (UI1)	Maximum Scaled Value specifies the minimum engineering unit for the input corresponding to the lowest value measured at the input connection

FE01 - FE05 Attr.	Data Type	Access	Store & Default	SP for Windows Location	Description
OI	FE	RW	EE 0	I/O Setup/ Input (UI1)	Override Input allows a host or operator to directly set the value of the source/duct temperature
RE	FE	R	RAM NA	I/O Setup/ Input (UI1)	Data Reliability an analog input value is considered unreliable if it is out of range for the selected sensor type
ST	FE	RW	EE 7	I/O Setup/ Input (UI1)	Sensor Type selects one of the following input types: 0= digital 2= full scale, linear -5V dc or 0-20mA scaled from MN to MX 3= 4-20mA liner scaled from MN to MX 7= -22.0 to 122.0°F thermistor 1,4,5 and 6 unused
SU	FD	RW	EE 0.0	I/O Setup/ Input (UI1)	Amount of Setup/Setback Alarm Limit specifies the amount added to FE04;HL or subtracted from FE04;LL during unoccupied periods
AE	FE	RW	EE 0	I/O Setup/ Input (UI1)	Alarm Enable specifies the type of alarm checking to be done on the FE04;CV value 0=disabled 1= contact (0→1) 2=contact (1→0) 3=change of state (1↔0) 4=low limit alarm 5=high limit alarm 6=low and high limit
AS	FE	R	RAM 0	I/O Setup/ Input (UI1)	Alarm Status shows the current alarm condition 0=normal 1=contact (0→1) 2=contact (1→0) 3=change of state 4=unused 5=low limit alarm 6=high limit alarm

ZONE TEMPERATURE CHANNEL, FE00

FE00 Attr.	Data Type	Access	Store & Default	SP for Windows Location	Description
ZT	FD	RW (W if FE00; OI = 1)	RAM NA	Temperature/ Thermostat	Zone Temperature shows the current temperature value measured by the thermostat as adjusted by FE00; OF
AE	FE	RW	EE 0	Temperature/ Alarms	Enable Alarming specifies the type of alarm checking to be done on the CV value 0=disabled 4=low limit alarm 5=high limit alarm 6=low and high limit 1-3 and 7-12 are unused
AS	FE	R	RAM 0	Temperature/ Alarms	Alarm Status shows the current alarm condition 0=normal 5=low limit 6=high limit 1-4 and 7-12 are unused
BM	FE	RW	0	Temperature/ Sensor Bus	Bus Mode should be set to Master (FE00; BM =0) unless multiple controllers are wired onto a SSB. Any additional controllers on the SSB must be configured as Slaves (FE00; BM =1).
BT	FE	RW	EE 1 cooling only	Temperature/ Thermostat	Control Mode this attribute specifies the type of VAV terminal box being used 0 = none 1 = cooling only 2 = heating only 3 = supply dependant
CC	FD	R	RAM NA	Temperature/ Cooling Setpoints	Current Setpoint this attribute shows the current cooling control setpoint
CH	FD	R	RAM	Temperature/ Heating Setpoints	Current Setpoint this attribute shows the current heating control setpoint
CV	FD	RW	RAM NA	Temperature/ Alarms	Current Value shows the current value of the input

FE00 Attr.	Data Type	Access	Store & Default	SP for Windows Location	Description
DF	RE	RW	EE 3 ##.#	Temperature/ Sensor Bus	Display Format defines the format used to display the current temperature on the digital thermostat. The display of the tenths digit and the Fahrenheit/Celsius character are options. Also, the display may be eliminated. 0 = ##d 1 = ##.#d 2 = ##dF 3 = ##.#dF 4 = None
DL	FD	R	NA	Temperature/ Thermostat	Demand Load indicates the heating/cooling demand in terms of the temperature separation from setpoints
DM	FE	R	NA	Temperature/ Thermostat	Zone Demand indicates the demand for the zone
DS	FE	RW	EE 0 degre es F	Temperature/ Sensor Bus	Display Mode specifies whether English or Metric units are to be used for the digital thermostat display 0 = Fahrenheit 1 = Celsius
DV	FE	RW	0	Temperature/ Sensor Bus	Display Value , when FE00; DV =0 each digital thermostat displays the identical temperature value (average) (FE00; ZT). When FE00; DV =1 each thermostat displays its own temperature
ED	FE	RW	EE 60 minutes	Temperature/ Override	Extended Occupancy Duration this attribute specifies the amount of time, in minutes, to extend occupancy
ER	FE	R	RAM NA	Temperature/ Override	Extended Occupancy Remaining this attribute shows the amount of time remaining in extended occupancy
G0	FE	R	NA	Temperature/ Sensor Bus	GID Device 0 is the global identification for the SSB device
G1	FE	R	NA	Temperature/ Sensor Bus	GID Device 1 is the global identification for the SSB device
G2	FE	R	NA	Temperature/ Sensor Bus	GID Device 2 is the global identification for the SSB device

FE00 Attr.	Data Type	Access	Store & Default	SP for Windows Location	Description
G3	FW	R	NA	Temperature/ Sensor Bus	GID Device 3 is the global identification for the SSB device
HL	FD	RW	EE 0.0	Temperature/ Alarms	High Alarm Limit if alarms are enabled and the current value rises above this value, a high limit alarm will be generated
HS	FD	RW	EE 0.0	Temperature/ Alarms	Alarm Limit Hysteresis determines when the SBC-ASC(e) returns from a high or low limit alarm
LL	FD	RW	EE 0.0	Temperature/ Alarms	Low Alarm Limit if alarms are enabled and the current value drops below this value, a low limit alarm will be generated
NC	FD	RW	EE 5.0	Temperature/ Cooling Setpoints	Night Setback this attribute specifies, in +/- degrees, the amount to be added to the cooling setpoint (FE00; SC) when the SBC-ASC(e) is in night setback mode
NH	FD	RW	EE 10.0°F	Temperature/ Heating Setpoints	Night Setback this attribute specifies, in +/- degrees, the amount to be added to the heating setpoint (FE00; SH) when the SBC-ASC(e) is in night setback mode
OF	FD	RW	EE 0	Temperature/ Thermostat	Temperature Correction this defines the correction that is being applied to temperature readings
OI	FE	RW	EE 0	Temperature/ Thermostat	Override Temperature Value when set to 1, it allows you to write to FE00;ZT directly
PB	FE	RW	EE 2200	Temperature/ Sensor Bus	Balancer P.I.N. this personal identification number controls access to the Balance Menu
PG	FE	RW	EE 0	Temperature/ Sensor Bus	Primary GID specifies the GID of the Primary SBC-STAT in Primary GID mode (RM=8). If this SBC-STAT is not available then the Average temperature mode (RM=0) is used.

FE00 Attr.	Data Type	Access	Store & Default	SP for Windows Location	Description
PI	FE	RW	EE 3300	Temperature/ Sensor Bus	Installer P.I.N. this Personal Identification Number controls access to all menus.
PS	FE	RW	EE 1100	Temperature/ Sensor Bus	Service P.I.N. this personal identification number controls access to the Service Menu
PU	FE	RW	EE 0	Temperature/ Sensor Bus	User P.I.N. this personal identification number controls access to the User Menu
RM	FE	RW	EE Average	Temperature/ Sensor Bus	Reading Mode specifies the technique used to determine Zone Temperature when multiple SBC-STATs are used. 0 = Average 1 = Highest 2 = Lowest 3 = Hi/Lo VST mode 4-7 = Device 0-Device 3 8 = Primary GID
SC	FD	RW	EE 72.0	Temperature/ Cooling Setpoints	Cooling Setpoint shows the zone temperature setpoint desired to begin cooling control
SD	FE	RW	EE 0	Temperature/ Setpoint Adjust	Calculated Setpoint Display Users can select a method of setpoint adjustment that is displayed when users adjust the setpoint on an SBC-STAT3.
SE	FE	RW	EE 1 enabled	Temperature/ Override	User Override this attribute enables or disables your ability to enter extended occupancy override
SH	FD	RW	EE 68.0°F	Temperature/ Heating Setpoints	Heating Setpoint this attribute shows the zone temperature setpoint desired to begin heating control
SU	FE	RW	EE 0.0	Temperature/ Alarms	Amount to Setup/ Setback Alarm Limit specifies the amount added to HL or subtracted from LL during unoccupied periods
SW	FD	RW	EE 72.0°F	Temperature/ Heating Setpoints	Warm-up Setpoint shows the zone temperature setpoint desired for beginning warm-up heating control
T0	FE	R	NA	Temperature/ Sensor Bus	Reading Device 0 is the raw reading for Device 1 on a SSB

FE00 Attr.	Data Type	Access	Store & Default	SP for Windows Location	Description
T1	FE	R	NA	Temperature/Sensor Bus	Reading Device 1 is the raw reading for Device 2 on a SSB
T2	FE	R	NA	Temperature/Sensor Bus	Reading Device 2 is the raw reading for Device 3 on a SSB
T3	FE	R	NA	Temperature/Sensor Bus	Reading Device 3 is the raw reading for Device 4 on a SSB
TM	FD	RW	EE 0.5°F	Temperature/Setpoint Adjust	User Adjust Increment this attribute specifies the magnitude of incremental changes to the User Setpoint Offset (FE00;TS)
TP	FF	RW	RAM 0	Temperature/Setpoint Adjust	User Adjust Position the User Setpoint Offset (FE00;TS) can be raised or lowered in integral steps; the FE00;TP attribute tracks the current step
TR	FE	RW	RAM 0	Temperature/Setpoint Adjust	User Adjust Remaining displays the time remaining before the User Setpoint Offset (FE00;TS) setting is reset
TS	FD	R	RAM 0	Temperature/Setpoint Adjust	User Setpoint Offset this attribute defines an offset to be applied to PID setpoints
TT	FE	RW	EE 120 minutes	Temperature/Setpoint Adjust	User Setpoint Offset the User Setpoint Offset (FE00;TS) is a a temporary setting; the FE00;TT attribute defines in minutes the duration for which the setting applies
UC	FD	RW	EE 5.0	Temperature/Cooling Setpoints	Unoccupied Setback this attribute specifies, +/- degrees, the amount to be added to the cooling setpoint (FE00;SC) when the SBC-ASC(e) schedule is in unoccupied mode
UH	FD	RW	EE 10.0°F	Temperature/Heating Setpoints	Unoccupied Setback specifies, in +/- degrees, the amount to be added to the heating setpoint (FE00;SH) when the SBC-ASC(e) is in unoccupied mode

FE00 Attr.	Data Type	Access	Store & Default	SP for Windows Location	Description
ZS	FD	RW	RAM 70.0	Temperature/Setpoint Adjust	Zone Midpoint displays the midpoint between the current cooling and heating setpoints.

ANALOG OUTPUT CHANNEL, FD01-
FD04

FD01 - FD04 Attr.	Data Type	Access	Store & Default	SP for Windows Location	Description
CV	FC	RW	RAM 0.0	I/O Setup/ Output (AO1)	Current Output Value shows the current value of the analog output
DT	FE	RW	EE 252	I/O Setup/ Output (AO1)	Data Type for Output specifies the PUP data type for the analog output
HS	FA	RW	EE 100.0	I/O Setup/ Output (AO1)	Maximum Scaled Voltage specifies the actual analog output value for a FD01; CV value of FD01; MX
LS	FA	RW	EE 0.00	I/O Setup/ Output (AO1)	Minimum Scaled Voltage specifies the actual analog output value for a FD01; CV value of FD01; MN
MN	FC	RW	EE 0.0	I/O Setup/ Output (AO1)	Minimum Scaled Value specifies the minimum scaled value for the analog output corresponding to the lowest value output
MX	FC	RW	EE 100.0	I/O Setup/ Output (AO1)	Maximum Scaled Value specifies the maximum scaled value for the analog output corresponding to the highest value output
AM	FE	RW	EE 0	I/O Setup/ Output (AO1)	Automatic/Manual Control selects the control mode for the analog output 0 = manual 1 = automatic

PULSE CHANNEL, FC03

FC03 Attr.	Data Type	Access	Store & Default	SP for Windows Location	Description
CV	FE	R	N/A	Aux/ Pulse Channel	Current State reports the current status, 0 or 1, for the binary inputs
MD	FE	RW	0	Aux/ Pulse Channel	Counter Mode select an option for the counter 0 = Disabled 1 = falling edges 2 = enabled to count on signal rising edges 3 = both edges
NP	FE	RW	0	Aux/ Pulse Channel	Pulse Count reports the count of detected edges. To clear or initialize the count, you can write to this attribute.
SF	F9	RW	0.000	Aux/ Pulse Channel	Pulse Scale Factor the weighted value of each pulse count
SV	F9	R	0.000	Aux/ Pulse Channel	Pulse Scaled Value the product of the current pulse count and the pulse scale factor

FAN STATUS CHANNEL, FC02

FC02 Attr.	Data Type	Access	Store & Default	SP for Windows Location	Description
PF	FE	R	N/A	Aux/Fan Status	Fan Status shows that status of the fan
IC	FE	RW	0= None	Aux/Fan Status	Status Input selects the digital input where a non-zero value indicates flow 0 = None 1 = UI1 2 = UI2 3 = UI3 4 = UI4 5 = UI5 6 = OIA/B
PD	FE	RW	60	Aux/Fan Status	Delay shows the amount of time, in seconds, imposed before enabling a positive flow indication

OCCUPANCY DETECTOR CHANNEL, FC01

FC01 Attr.	Data Type	Access	Store & Default	SP for Windows Location	Description
MS	FE	R	RAM NA	Aux/ Occupa ncy Detector	Occupancy Status shows the status of the occupancy detector digital input
MT	FE	RW	EE 0	Aux/ Occupa ncy Detector	Extended Occupancy Duration defines, in minutes, the length of time to override the zone whenever occupancy is detected
IC	FE	RW	EE 0	Aux/ Occupa ncy Detector	Status Input selects which input to use 0 = None 1 = UI1 2 = UI2 3 = UI3 4 = UI4 5 = UI5 6 = OIA/B
MD	FE	RW	EE 30	Aux/ Occupa ncy Detector	Extended Occupancy Delay sets the amount of time, in seconds, during which the occupancy detector must remain on before it will override the zone
MR	FE	R	RAM NA	Aux/ Occupa ncy Detector	Extended Occupancy Remaining displays the time remaining for occupancy detector override

DIGITAL OUTPUT CHANNEL (K1-K5), FB01-FB05

FB01-FB05 Attr.	Data Type	Access	Store & Default	SP for Windows Location	Description
CV	FE	RW	RAM NA	I/O Setup/ Relay Outputs	Current Output Value shows the current value for the analog output
OI	FE	RW	EE 0 Off	I/O Setup/ Relay Outputs	Override overrides the digital output. On (OI = 1) constantly energizes the output; Off (OI = 0) disables the output; Auto (OI = 2) allows for automatic control; Manual (OI = 3) allows the CV to be directly written. The factory default setting is OI = 1 (Off) to allow full configuration before equipment operation. Each digital output must be manually enabled.
OP	FE	RW	EE 0	I/O Setup/ Relay Outputs	Output Polarity allows you to change the polarity of the output 0 = normal 1 = reverse
RH	FC	RW	*	I/O Setup/ Relay Outputs	Runtime Hours shows the total amount of time, in hours, during which the output has been energized
RL	FC	RW	EE 0.0	I/O Setup/ Relay Outputs	Runtime Limit specifies a run time limit in hours for the output

FAN DIGITAL OUTPUT CHANNEL (K1), FB01

FB01 Attr.	Data Type	Access	Store & Default	SP for Windows Location	Description
CV	FE	RW	RAM NA	Equipme nt/Fan	Fan defines the status of the fan output
RS	FE	R	RAM NA	Equipme nt/Fan	Fan Running Speed indicates the fan speed current present
SP	FE	RW	0	Equipme nt/Fan	Fan Speeds specifies how many fan speeds the application will use
CS	FE	RW	0	Equipme nt/Fan	Set Fan Speed provides a method to allow users to command the fan across the network.
FD	FE	RW	30	Equipme nt/Fan	Shutoff Delay shows the amount of time, in seconds, the fan output will stay energized once the zone temperature reaches the deadband
FN	FE	RW	0	Equipme nt/Fan	Night Setback Mode defines the mode of the fan during the night setback schedule state. When FN = 1, the fan runs for the entire period. When FN = 0, the fan shuts off when the zone temperature is within the deadband.
FO	FE	RW	EE 0	Equipme nt/Fan	Occupied Mode defines the mode of the fan during the occupied schedule state. When FO = 1, the fan runs for the entire period. When FO = 0, the fan shuts off when the zone temperature is within the deadband.
FU	FE	RW	0	Equipme nt/Fan	Unoccupied Mode defines the mode of the fan during the unoccupied schedule state. When FU = 1, the fan runs for the entire period. When FU = 0, the fan shuts off when the zone temperature is within the deadband.

*Run hours are automatically backed up at midnight; restoration occurs when the unit is powered up after loss of power or after a reset.

PID CONTROL CHANNEL, FA11-FA14

FA11 - FA14 Attr.	Data Type	Access	Store & Value	SP for Windows Location	Description
AO	FC	RW	RAM NA	Aux/PID Control	Analog Output Value shows the scaled output value used by the analog output
CE	FE	RW	EE 0	Aux/PID Control	Enable Control Loop enables the PID loop
CS	FD	R	RAM NA	Aux/PID Control	Calculated Control Setpoint shows the actual loop control setpoint
DB	FC	RW	EE 0	Aux/PID Control	Deadband specifies the input variable range in which no control action occurs
IC	FE	RW	EE 0	Aux/PID Control	Loop Measured Variable specifies the input to be used for the measured variable for the control loop 0= disabled 1=Zone Temp 2=Supply Temp 4=UI1 5=UI2 6=UI3 7=UI4 8=UI5 11=Outside Air Temperature
ID	FE	RW	EE 0	Aux/PID Control	Interlock Enable/Disable enables/disables the interlocks for the PID. When an interlock input is = 1 (enabled), the PID control output is set to the value of the interlock failure position.
IN	FC	R	RAM 0	Aux/PID Control	Measured Variable's Value displays the value of the input selected in FA04;IC
MR	FC	RW	EE 0	Aux/PID Control	Maximum Amount to Reset Setpoint specifies the maximum amount by which to reset the loop setpoint (SP) when reset is being used
PB	FC	RW	EE 0	Aux/PID Control	Proportional Band specifies the input variable range over which the output value is proportional to the error value
PO	FC	R	RAM NA	Aux/PID Control	Percent Output Value shows the output value in hundredths of a percent

FA11 - FA14 Attr.	Data Type	Access	Store & Value	SP for Windows Location	Description
P1	FC	RW	EE 0	Aux/PID Control	Interlock 1 Position specifies the PID output value when Interlock 1 is active and enabled.
P2	FC	RW	EE 0	Aux/PID Control	Interlock 2 Position specifies the PID output value when Interlock 2 is active and enabled.
P3	FC	RW	EE 0	Aux/PID Control	No Flow Position specifies the PID output value when the current value of Fan Status is equal to 0 (No Flow).
RC	FC	R	RAM NA	Aux/PID Control	Reset Variable's Value displays the value of the input selected in RV
RL	FC	RW	EE 0	Aux/PID Control	Limit for Maximum Reset specifies the value at which maximum reset is used
RP	FE	RW	EE 0	Aux/PID Control	Reset Period specifies the reset period (in seconds) over which the error history is accumulated
RS	FC	RW	EE 0	Aux/PID Control	Setpoint at Which Reset Action Begins specifies the value at which the reset action begins
RT	FC	RW	EE 0	Aux/PID Control	Derivative Rate specifies a percentage of change in error that is to be used in calculating FA04;PO
RV	FE	RW	EE 0	Aux/PID Control	Reset Variable specifies the input to be used for calculating the reset 0=disabled 1=Zone Temp 2=Supply Temp 4=UI1 5=UI2 6=UI3 7=UI4 8=UI5 11=Outside Air Temperature
SG	FE	RW	EE 0	Aux/PID Control	Control Action specifies the control action for the control loop 0 = normal 1 = reverse
SP	FD	RW	EE 0	Aux/PID Control	Loop Setpoint specifies the desired loop setpoint
SU	FC	RW	EE 0	Aux/PID Control	Unoccupied Setup/ Setback specifies the amount to add (if SG = 0) or subtract (if SG = 1) from the setpoint during an unoccupied period

VALVE CONTROL CHANNEL, FA08-FA09

FA08 - FA09 Attr.	Data Type	Access	Store & Value	SP for Windows Location	Description
VA	FE	RW	RAM NA	Equipment /Valve Control	Actual Valve Position shows the actual valve position based on travel time.
VD	FE	RW	RAM NA	Equipment /Valve Control	Desired Valve Position shows the desired valve position at which the loop should control the valve in order to bring the measured input variable closer to the setpoint
VI	FC	RW	EE 0.0	Equipment /Valve Control	Valve Integration Constant shows the amount of proportional error history (0 to 100%) used to calculate the desired position for the valve
VM	FE	RW	EE 0	Equipment /Valve Control	Valve Mode options are Pulse Width Modulation and Floating Point Motor Control 0 = Pulse Width Modulation 1 = Floating Point Motor Control
VO	FC	RW	EE 0.0	Equipment /Valve Control	Valve offset added to CC or subtracted from HC to determine the setpoint for the loop
VP	FC	RW	EE 5.0	Equipment /Valve Control	Valve Proportional Band specifies the input variable range, in degrees (0.0 to 25.5), over which the output is proportional to the error value
VT	FE	RW	EE 180	Equipment /Valve Control	Valve Motor Travel Time shows the amount of time, in seconds, that it takes the valve motor to travel from a fully closed position to a fully opened one
VU	FE	RW	EE 0	Equipment /Valve Control	Valve Use options are disabled, cooling, and heating
AM	FE	RW	EE 0	Equipment /Valve Control	Auto/Manual Mode selects the control mode for the valve output(s) 0 = manual 1 = automatic

FA08 - FA09 Attr.	Data Type	Access	Store & Value	SP for Windows Location	Description
CD	FE	RW	EE 0	Equipment /Valve Control	Change Valve Direction used to set the direction of the valve outputs 0 = normal 1 = reverse
CL	FD	RW	55.0	Equipment /Valve Control	OAT Cooling Lockout stops the cooling stages from engaging if a reliable (FE09;RE=0) outside air temperature (FE09;CV) is available and below the temperature specified by this attribute
HL	FD	RW	105.0	Equipment /Valve Control	OAT Heating Lockout stops the cooling stages from engaging if a reliable (FE09;RE=0) outside air temperature (FE09;CV) is available that is above the temperature specified by this attribute
PP	FE	RW	EE 0	Equipment /Valve Control	Pulse Width shows the amount of time, in seconds, that the valve is to be pulsed ON when PE = 0 or pulse width modulation is enabled
RI	FE	RW	EE 0	Equipment /Valve Control	Recalibrate Interval shows the amount of time, from 1 to 255 hours, between valve calibrations. Calibration is disabled when RI = 0. The default is 0. Note that if RI = 0 and a power failure occurs, the valve will not be recalibrated upon power-up.
ST	FE	RW	0	Equipment /Valve Control	Valve Status indicates the status of the valve channel
TH	FD	RQ	80.0	Equipment /Valve Control	DAT High Temp Lockout heating stages will be engaged if there is a reliable source/duct temperature below this setting
TL	FD	RW	45.0	Equipment /Valve Control	DAT Low Temp Lockout cooling stages will be engaged if there is a reliable source/duct temperature above this setting
UT	FE	RW	5.0	Equipment /Valve Control	Update Threshold used to minimize the actuation of the valve for insignificant changes

FA08 - FA09 Attr.	Data Type	Access	Store & Value	SP for Windows Location	Description
CC	FE	RW	0	Equipment /Valve Control	Changeover Control Input Defines the input used for heating/ cooling changeover
CS	FC	RW	0	Equipment /Valve Control	Changeover Cooling Setpoint defines the setpoint for cooling changeover
HS	FC	RW	0	Equipment /Valve Control	Changeover Heating Setpoint defines the setpoint for heating changeover

ELECTRIC REHEAT CHANNEL, FA03

FA03 Attr.	Data Type	Access	Store & Value	SP for Windows Locations	Description
EN	FE	R	RAM NA	Aux/ Electric Reheat	Energized Stages displays those reheat stages that are currently energized
FR	FE	RW	EE 15	Aux/ Electric Reheat	Stages Requiring Flow defines by the appropriate bit setting which of the available reheat stages requires a positive flow indication
ID	FC	RW	EE 4.0	Aux/ Electric Reheat	Stage Delay shows the minimum amount of time, in minutes, before the next reheat stage will be energized
MX	FD	RW	EE 105.0	Aux/ Electric Reheat	Maximum Supply Temperature establishes a maximum supply duct temperature above which the reheats will de energize
OF	FC	RW	EE 1.5°F	Aux/ Electric Reheat	Reheat Offset specifies, in degrees, the offset from the calculated heating control setpoint (FE00;HC) that determines the temperature below which additional reheat stages can be energized
RO	FE	RW	EE 0	Aux/ Electric Reheat	Reheat Options used to configure the SBC-ASC(e)'s outputs for electric reheat 0 = 2 stage electric reheat (K2 and 3) 2 = 2 stage electric reheat (K4 and 5) 3 = 4 stage electric reheat (K2,3,4 and 5)
AF	FE	RW	EE 1	Aux/ Electric Reheat	Require Max Airflow if set to "Yes" (FA03;AF = 1), this holds off the addition of reheat stages until the PID loop is calling for maximum airflow
AV	FE	R	RAM NA	Aux/ Electric Reheat	Available Stages displays the stages that are currently available for use
BA	FE	RW	EE 0	Aux/ Electric Reheat	Balance Stage Usage if set to "Yes" (FA03;BA = 1), this attribute considers the Run Hour Totals (FB0x;RH) for the individual relay outputs in energizing reheat stages

ECONOMIZER CHANNEL, FA01

FA01 Attr.	Data Type	Access	Store & Default	SP for Windows Location	Description
EE	FE	RW	EE 0	Auxiliary/ Economizer	Economizer Enable specifies the PID channel or DO to be used for economizer control. 0=Off 1=PID 1 2=PID 2 3=PID 3 4=PID 4 5=DO 3 6=DO 5
OH	FD	RW	EE 60.0	Auxiliary/ Economizer	OAT High Limit If the OAT is above the high limit and the economizer is enabled, the PID is set to the Minimum Position (as specified in FA01;EM).
OL	FC	RW	EE 45.0	Auxiliary/ Economizer	OAT Low Limit If the OAT is below the low limit and the economizer is enabled, the PID is set to the Minimum Position (as specified in FA01;EM).
EM	FC	RW	EE 10.0	Auxiliary/ Economizer	Minimum Position specifies the PID minimum position in percent for the economizer damper.
ED	FC	RW	EE 1.0	Auxiliary/ Economizer	Economizer Staging Delay Specifies how many minutes the controller waits before using additional cooling stages after the economizer damper reaches 100%.
CM	FC	RW	RAM N/A	Auxiliary/ Economizer	Calculated Minimum Position displays the actual minimum position of the economizer damper
MV	FC	RW	EE 0	Auxiliary/ Economizer	Reset variable allows you to specify an input sensor that is to be used to reset the minimum position of the economizer (FA01;EM).
MP	FC	RW	EE 0	Auxiliary/ Economizer	Reset Setpoint Specifies the value at which the reset action begins. When the value of the reset variable exceeds MP , reset action will be used in determining the economizer minimum position.

FA01 Attr.	Data Type	Access	Store & Default	SP for Windows Location	Description
MR	FC	RW	EE 0	Auxiliary/ Economizer	Maximum Reset specifies the maximum amount by which to reset the minimum position setpoint (EM) when reset is being used.
ML	FC	RW	EE 0	Auxiliary/ Economizer	Reset Limit When the value of the reset variable is equal to ML , the maximum reset (MR) is used in determining the calculated minimum position.

SCHEDULE 1 THROUGH SCHEDULE 6 CHANNEL, F901-F906

F901-F906 Attr.	Data Type	Access	Store & Default	SP for Windows Location	Description
CV	FE	R	RAM NA	Schedules /1-6	Current Schedule Value indicates the current state of the schedule: 0 = unoccupied mode, 1 = warm-up, 2 = occupied mode, 3 = night setback
NS	E6	RW	EE 19:00	Schedules /1-6	Night Setback start time in short military format when night setback should begin
OC	E6	RW	EE 08:00	Schedules /1-6	Occupied Time start time in short military format when occupied mode should begin
UN	E6	RW	EE 17:00	Schedules /1-6	Unoccupied Time start time in short military format when unoccupied mode should begin
WO	E6	RW	EE 07:00	Schedules /1-6	Warm-up Time start time in short military format when warm-up mode should begin
AD	E9	RW	EE M T W T F	Schedules /1-6	Active Days Day-of-week map specifying which of eight possible days of the week (seven days plus holiday) that the schedule is active 0 = Monday 1 = Tuesday 2 = Wednesday 3 = Thursday 4 = Friday 5 = Saturday 6 = Sunday 7 = Holiday
AO	FE	RW	EE 0	Schedules /1-6	All-Day Override this attribute is used to override the schedule in WO , OC , UN , and NS for active days

MAIN SCHEDULE CHANNEL, F900

F900 Attr.	Data Type	Access	Store & Default	SP for Windows Location	Description
CV	FE	R	RAM NA	Schedules/ Summary	Current Value for Schedule read only attribute that displays the present schedule operating state of the SBC-ASC(e) as determined by priority checking 0 = unoccupied 1 = warm-up 2 = occupied 3 = night setback
DA	FE	RW	RAM NA	Schedules/ Clock/ Calendar	Day of the Week specifies the current day of the week as a number from 0–7; must be set by a host controller for proper operation (default invalid): bit #0 = Monday bit #1 = Tuesday bit #2 = Wednesday bit #3 = Thursday bit #4 = Friday bit #5 = Saturday bit #6 = Sunday
DH	FE	RW	RAM	Schedules/ Clock/ Calendar	Holiday toggles the holiday status for the current day
DT	E4	RW	RAM NA	Schedules/ Clock/ Calendar	Current Date specifies the current date in MM/DD/YY format.
H0-H9	E4	RW		Schedules/ Clock/ Calendar	Programmed Holiday specified date to be considered a holiday. Set this attribute to 0/0/YY to ignore
HE	FE	RW	EE 0	Schedules/ Summary	Host Schedule Override Enable specifies whether the SBC-ASC(e) will operate from its local schedules or from a host on the network: 0 = CV is set by schedules F901–F906, 1 = CV is set by HO (ZE must = 0)
HO	FE	RW	RAM 0	Schedules/ Summary	Host Schedule Override specifies the desired schedule override state of the SBC-ASC(e) when HE = 1: 0 = unoccupied 1 = warm-up 2 = occupied 3 = night setback

F900 Attr.	Data Type	Access	Store & Default	SP for Windows Location	Description
IS	FE	RW	EE 3	Schedules/ Summary	Inactive Schedule specifies which of the four possible schedule modes is used by the SBC-ASC(e) schedules during inactive schedule periods (when current day of the week is not an active day) 0 = unoccupied 1 = warm-up 2 = occupied 3 = night setback
TM	E6	RW	RAM NA	Schedules/ Clock/ Calendar	Time specifies the current system time (HH:MM) in military format from 00:00 to 23:59 (default invalid)
ZE	FE	RW	EE 0	Schedules/ Summary	Zone Schedule Enable used to set the current schedule mode for the entire zone from the network broadcast of a controller capable of broadcasting zone schedule information to multiple SBC-ASC(e)s in the zone
AS	E9	R	RAM NA	Schedules/ Summary	Active Schedule Bitmap displays the currently active schedules in bitmap form bit #0=F901 bit #1=F902 bit #2=F903 bit #3=F904 bit #4=F905 bit #5=F906 Bits #6 and #7 are unused
C1	FE	R	RAM NA	Schedules/ Summary	Current Value of Schedule 1 reflects the current value of F901;CV
C2	FE	R	RAM NA	Schedules/ Summary	Current Value of Schedule 2 reflects the current value of F902;CV
C3	FE	R	RAM NA	Schedules/ Summary	Current Value of Schedule 3 reflects the current value of F903;CV
C4	FE	R	RAM NA	Schedules/ Summary	Current Value of Schedule 4 reflects the current value of F904;CV
C5	FE	R	RAM NA	Schedules/ Summary	Current Value of Schedule 5 reflects the current value of F905;CV
C6	FE	R	RAM NA	Schedules/ Summary	Current Value of Schedule 6 reflects the current value of F906;CV

SCHEDULE BROADCAST CHANNEL,
F005

F005	Data Type	Access	Store & Default	SP for Windows Location	Description
CV	FE	R	RAM 0	Network/ Schedule Broadcast	Current Value shows the current value of the network broadcast schedule values received by the SBC-ASC(e)
RB	FE	RW	EE 0	Network/ Schedule Broadcast	Receive Broadcast enables the SBC-ASC(e) to receive network broadcasts and sets the F900; CV value based on the received value

OUTSIDE AIR TEMPERATURE (OAT)
CHANNEL, F000

F000	Data Type	Access	Store & Default	SP for Windows Location	Description
CV	FD	R	RAM 0	Network/ OAT Broadcast	Current Value shows the current value of the network broadcast OAT value received by the SBC-ASC(e)
RB	FE	RW	EE 0	Network/ OAT Broadcast	Receive Broadcast enables the SBC-ASC(e) to receive network broadcasts and sets the F900; CV value based on the received value
BE	FE	RW	0	Network/ OAT Broadcast	Broadcast Enable enables active broadcast of a reliable FE09; CV Outside Air Temperature (OAT)

